



***Aspen Spas congratulates you on your decision
to enjoy the finest spa available.
Welcome to the growing family of Aspen Spas owners.***

Before you begin reviewing the manual, please take a moment to register your warranty. By doing so will help assist us in contacting you for any important product notification and ensure that you and other can enjoy quality products for years to come.
Prior to registering, you will need the serial number that is located on your Aspen Spa.

FOR YOUR RECORDS

Spa Model: _____

Serial Number: _____

Date Purchased: _____

Address: _____

Dealer : _____

If you have any questions about any aspect of your spa's set-up, operation, or maintenance, contact your authorized **Aspen Spas** dealership. They are trained professionals who are familiar with the product as well as new spa ownership concerns. Their expertise will facilitate the enjoyment of your new Aspen spa.

IMPORTANT: Aspen Spas reserves the right to change specifications, or design, without notification and without incurring any obligation.



In most cities and counties, permits will be required for the installation of electrical circuits or the construction of exterior surfaces (decks and gazebos). In addition, some communities have adopted residential barrier codes which may require fencing and/or self-closing gates on the property to prevent unsupervised access to a pool (or spa) by children under 5 years of age. Your Aspen spa is equipped with a locking cover that meets the ASTM F1346-91 Standard for Safety Covers and as a result, is usually exempt from most barrier requirements. As a general practice, your local Building Department will inform you of any applicable barrier requirements at the time a permit is obtained for the installation of an electrical circuit.

Your **Aspen Spas** dealer can provide information on which permits may be required.

TABLE OF CONTENTS

SAFETY INFORMATION	3	CHLORINE ODOR	22
IMPORTANT SAFETY INSTRUCTIONS	3	SCUM	22
IMPORTANT SPA INSTRUCTIONS	8	FOAM	22
ELECTRICAL REQUIREMENTS	8	EYE IRRITATION	22
WHERE BEST TO INSTALL A HOT TUB	11	SKIN IRRITATION	22
LOCATION OF YOUR ASPEN SPA	11	STAINS	22
INSTALLATION OF YOUR ASPEN SPA	12	SCALE	23
PREPARING FOR YOUR ASPEN SPA	13	WATER MAINTENANCE	
PRE-DELIVERY INFORMATION	14	TROUBLESHOOTING GUIDE	23
SPA START-UP	15	WATER TERMINOLOGY	23
BEFORE YOU FILL YOUR ASPEN SPA	15	HOT TUB TROUBLESHOOTING	24
START-UP	15	PRIMING THE PUMP	24
PRIMING THE PUMP	16	CHANGING THE FILTER	24
MAINTENANCE	17	REPLACING THE JETS	25
WATER QUALITY	19	REPLACING THE PILLOWS	25
BASIC INFORMATION	19	DRAINING AND REFILLING	25
WATER QUALITY CHART	19	TRIPPING GFCI	26
CHEMICAL SAFETY	20	POWER OUTAGE	26
HOW TO ADD CHEMICALS	20	OPERATING INSTRUCTIONS GECKO	27
FUNDAMENTALS OF		IN.K300	27
WATER MAINTENANCE	20	IN.K500	29
VACATION WATER CARE	21	IN.K800	32
SHORT TIME PERIODS	21	IN.K1000	38
LONG TIME PERIODS	21	OPTIONS	49
WATER CARE TROUBLESHOOTING	21	IN.TOUCH 2	49
CLOUDY WATER	21	IN.STREAM 2	51
MUSTY ODOR/ALGAE	21	ASPEN SPAS SPECIFICATION	54

SAFETY INFORMATION

IMPORTANT SAFETY INSTRUCTIONS

 READ AND FOLLOW ALL INSTRUCTION.

 SAVE THESE INSTRUCTIONS.

 **DANGER** - RISK OF ACCIDENTAL DROWNING - RISK OF CHILD DROWING

Extreme caution must be exercised to prevent unauthorized access by children. To avoid accidents, ensure that children cannot use a spa unless they are supervised at all times.

 **DANGER** – Risk of Injury. The suction fittings in this spa are sized to match the specific water flow created by the pump. Should the need arise to replace the suction fittings or the pump, be sure that the flow rates are compatible. Never operate spa if the suction fittings are broken or missing. Never replace a suction fitting with one rated less than the flow rate marked on the original suction fitting.

 **DANGER** – Risk of Electric Shock. Install at least 6 feet (1.5 m) from all metal surfaces. As an alternative, a spa may be installed within 6 feet of metal surfaces if each metal surface is permanently connected by a minimum 8 AWG (8.4 mm²) solid copper conductor to the wire connector on the terminal box that is provided for this purpose.

 **DANGER** – Risk of Electric Shock. Do not permit any electric appliance, such as a light, telephone, radio, or television, within 6 feet (1.5 m) of a spa.

 **DANGER** – The appliance is not to be used by persons (including children) with reduced physical, sensory or mental capabilities, or lack of experience and knowledge, unless they have been given supervision or instruction.

 **WARNING**

- To reduce the risk of injury, do not permit children to use this spa unless they are closely supervised at all times. Extreme caution must be exercised to prevent unauthorized access by children. To avoid accidents, insure that children are supervised at all times.
The water in a spa should never exceed 104°F (40°C). Water temperatures between 100°F (37.7°C) and 104°F (40°C) are considered safe for a healthy adult. Lower water temperatures are recommended for extended use (exceeding 10 minutes) and for young children. Extended use can cause Hyperthermia.
- A wire connector is provided on this unit to connect a minimum 8 AWG (8.4 mm²) solid copper conductor between this unit and any metal equipment, metal enclosures of electrical equipment, metal water pipe, or conduit within 6 feet (1.5 m) of the unit.
- Prolonged immersion in hot water can result in HYPERTHERMIA, a dangerous condition which occurs when the internal temperature of the body reaches a level above normal (98.6°F, 37°C). The symptoms of hyperthermia include unawareness of impending hazard, failure to perceive heat, failure to recognize the need to exit the spa, physical inability to exit the spa, fetal damage in pregnant women, and unconsciousness resulting in a danger of drowning.
- To reduce the risk of injury, before entering a spa the user should measure the water temperature with an accurate thermometer.
- Since excessive water temperatures have a high potential for causing fetal damage during the early months of pregnancy – pregnant, or possible pregnant women, should limit spa temperature to 100°F (37.7°C). Consult your physician before using spa.
- Persons suffering from obesity or with a medical history of heart disease, low or high blood pressure, circulation system problems or diabetes, should consult a physician before using a spa.
- The use of alcohol, drugs, or medication, before or during spa use, may lead to unconsciousness with the possibility of drowning.
- Persons using medication should consult a physician before using a spa since some medication may induce drowsiness, while other medication may affect heart rate, blood pressure and circulation.
- Persons taking medication which induce drowsiness, such as tranquilizers, antihistamines or anticoagulants should not use the spa.
- Shower before and after using your spa. Maintaining water chemistry will reduce the possibility of contracting a waterborne illness.
- Each Aspen Spa is shipped with a SAFETY SIGN in the owner's package. The sign, which is required as a condition of Product Listing, should be permanently installed where it is visible to the users of the spa. To obtain additional safety signs, contact your dealer.
- This unit should be subjected to periodic routine maintenance to make sure that the unit is operating properly.
- Precaution to avoid damage when the appliance is left empty for an extended period.
- The appliance should be supplied through a residual current device (RCD) with a rated tripping current not exceeding 30mA.

SAFETY DO'S AND DON'TS

- DO** Make sure the spa is connected to a Ground Fault Circuit Interrupter (GFCI).
- DO** Always supervise children during spa use.
- DO** Test the water with your hand before entering the spa to be sure it is comfortable.
- DO** Remember that wet surfaces can be slippery. Take care when entering and exiting the spa. Do not step on the spa edges or filter lids.
- DO** Use the spa cover when the spa is not in use. Make sure you always lock the child resistant locks after using the spa for your children's safety.
- DO** Maintain proper water chemistry. Follow the Spa Care and Maintenance recommendations stated in this manual.
- DO** Use only approved accessories and recommended spa chemical cleaners.
- DO** Clean the filter cartridge twice a month to remove debris and mineral buildup which may affect the performance of the hydromassage jets, limit the flow, or trip the high-limit thermostat which will turn off the entire spa.
- DO** Keep the water cleaned and sanitized with correct chemical care.
The recommended levels for your Aspen Spa are:



Free Available Chlorine: 3.0-5.0 ppm	Total Alkalinity: 40-120 ppm
Water pH: 7.2-7.6	Calcium Hardness: 50-150 ppm

Refer to Water Quality and Maintenance section for complete instructions.

Important: Turn jet pump on and leave the cover open for at least 10 minutes after adding ANY spa water chemicals

- DON'T** Use the spa for long periods of time at temperatures of 104°F (40°C).
- DON'T** Use spa directly after strenuous exercise.
- DON'T** Allow anyone with infectious diseases to use spa. Please consult your physician.
- DON'T** Operate the spa without water. Turn circuit breaker off before emptying the spa, and while the spa is empty.
- DON'T** Sit in the filter compartment area. Sitting in this area can cause: a) Restriction of filter pump suction/vacuum. b) Damage to components. Both can result in bodily harm. Should damage occur to components in this area, replace immediately!
- DON'T** Remove floating weir, basket, and filter located in the filter compartment while the spa is running.
- DON'T** Replace a suction fitting with one rated less than the flow rate marked on the original suction fitting. They are sized to match the specific water flow created by the pump.
- DON'T** Operate spa if the suction fittings are broken or missing.
- DON'T** Keep any loose articles of clothing or hanging jewelry near rotating jets or other moving components.
- DON'T** Leave the spa exposed to the sun without water or the vinyl cover in place. Exposure to direct sun light can cause solar distress of the shell material and will void the warranty.
- DON'T** Roll or slide the spa on its side. This will damage the siding.
- DON'T** Lift or drag the cover by using the cover lock straps or the center pillows; always lift or carry the cover by using the handles.
- DON'T** Allow children to climb onto the spa cover.
- DON'T** Store chemicals in the spa's equipment compartment.

AVOIDING THE RISK OF ELECTROCUTION

-  **DANGER - RISK OF ELECTROCUTION**
- Connect only to a grounded source.
 - To reduce the risk of electrical shock, replace a damaged cord immediately. Failure to do so may result in death or serious personal injury due to electrocution.
 - Your spa must be connected to a Ground Fault Circuit Interrupter for user and equipment protection. To ensure proper operation of this important safety device, test according to the following instructions per electrical configuration.
 - Do not operate the audio main controls while inside the spa (if spa is equipped with an audio component).
 - Do not connect any auxiliary components (for example, cable additional speakers, headphones, and additional audio components) to the audio system unless approved by Aspen Spas.
 - Do not self service audio component by opening spa door as this may expose dangerous voltage or other risk of injury. Refer all servicing to qualified service personnel.
 - Do not attach an external antenna to a spa audio system unless installed by a licensed electrician in accordance with Article 810 of the National Electric Code, ANSI/NFPA 70.
 - The appliance should be supplied through a residual current device (RCD) with a rated tripping current not exceeding 30mA.
-  **WARNING**
- Important safety device, test according to the following instructions per electrical configuration.

230 VOLT PERMANENTLY CONNECTED MODELS

- A ground terminal is provided on the terminal block located inside the control box. To reduce the risk of electric shock, connect this terminal to the grounding terminal of your electrical service or supply panel with a continuous green, insulated copper wire. The wire must be equivalent in size to the circuit conductors supplying the equipment. In addition, a bonding terminal (pressure wire connector) is provided on the outside of the control box for bonding to local ground points. To reduce the risk of electric shock, this connector should be bonded with a No. 8 AWG (8.4 mm²) solid copper wire to any metal ladders, water pipes, or other metal within 6 feet (1.5 m) of the spa to comply with local requirements. The means of disconnection must be readily accessible, but must be installed at least 6 feet (1.5 m) from the spa.
- We suggest to test the GFCI every 30 days. Turn it off, wait 30 seconds and then reset the GFCI, restoring power to the spa. If the interrupter does not perform in this manner, there may be an electrical malfunction and with it, the possibility of an electric shock. Disconnect the power until the problem has been corrected. **NOTE: This will reset the filter cycle.**

DANGER - RISK OF ELECTRICAL SHOCK

- Install at least 6 feet (1.5 m) from all metal surfaces. A spa may be installed within 6 feet of a metal surface if each metal surface is permanently connected by a minimum No. 8 AWG (8.4 mm²) solid copper conductor attached to the wire ground connector on the terminal box that is provided for this purpose if in accordance with National Electrical Code ANSI/NMFA70-1993.
- Do not permit any electrical appliances, such as a light, telephone, radio, or television within 6 feet (1.5 m) of a spa. Failure to maintain a safe distance may result in death, or serious personal injury due to electrocution, if the appliance should fall into the spa.
- Install your spa in such a way that drainage is away from the electrical compartment and from all electrical components.

SAFETY DO'S AND DON'TS

- DO** Make sure the spa is connected to a Ground Fault Circuit Interrupter (GFCI).
- DO** Make sure the spa is connected to the power supply correctly - use a licensed electrical contractor.
- DO** Disconnect the spa from the power supply before draining the spa or servicing the electrical components.
- DO** Test the GFCI before each use.

DON'T Use spa with the equipment door removed.

DON'T Place electrical appliances within 6 feet (1.5 m) of the spa.

DON'T Use an extension cord to connect the spa to its power source. The cord may not be properly grounded and the connection is a shock hazard. An extension cord may cause a voltage drop, which will cause overheating of the jet pump motor and motor damage.

DON'T Attempt to open the electrical control box. There are no user serviceable parts inside. Opening the control box by the spa owner will void the warranty. If you have an operational problem, carefully go through the steps outlined in the Troubleshooting section. If you are not able to resolve the problem, contact your authorized Aspen Spas dealer. Many problems can easily be diagnosed over the telephone by an authorized Aspen Service Technician.

RISKS TO AVOID

DANGER - RISK OF INJURY

- To reduce the risk of injury to persons, DO NOT remove suction fittings or suction covers.
- The suction fittings in the spa are sized to match the specific water flow created by the pump. Never replace a suction fitting with one rated less than the flow rate marked on the original suction fitting.
- There is a danger of slipping and falling. Remember that wet surfaces can be very slippery. Take care when entering or exiting the spa.
- Never operate spa if the suction fittings are broken or missing.
- People with infectious diseases should not use the spa.
- Keep any loose articles of clothing, long hair, or hanging jewelry away from rotating jets or other moving components.

INCREASED SIDE EFFECTS OF MEDICATION

- The use of alcohol, drugs or medication, before or during spa use, may lead to unconsciousness with the possibility of drowning.
- Persons using medication should consult a physician before using a spa since some medication may induce drowsiness, while other medication may affect heart rate, blood pressure and circulation.
- Persons taking medication which induce drowsiness, such as tranquilizers, antihistamines or anticoagulants should not use the spa.

HEALTH PROBLEMS AFFECTED BY SPA USE

- Since excessive water temperatures have a high potential for causing fetal damage during the early months of pregnancy-pregnant, or possible pregnant women, should limit spa temperature to 100°F (37.7°C). Consult your physician before using spa.
- Persons suffering from obesity or with a medical history of heart disease, low or high blood pressure, circulation system problems or diabetes, should consult a physician before using a spa.

UNCLEAN WATER

- Keep the water cleaned and sanitized with correct chemical care.
The recommended levels for your Aspen Spa are:

Free Available Chlorine: 3.0-5.0 ppm	Total Alkalinity: 40-120 ppm
Water pH: 7.2-7.6	Calcium Hardness: 50-150 ppm

Refer to Water Quality section for complete instructions.

Important: Turn jet pump on for at least 10 minutes after adding ANY spa water chemicals into the filter compartment.

AVOIDING THE RISK OF HYPERTHERMIA

- To reduce the risk of injury, do not permit children to use this spa unless they are closely supervised at all times. Extreme caution must be exercised to prevent unauthorized access by children. To avoid accidents, insure that children are supervised at all times.
- The water in a spa should never exceed 104°F (40°C). Water temperatures between 100°F (37.7°C) and 104°F (40°C) are considered safe for a healthy adult. Lower water temperatures are recommended for extended use (exceeding 10 minutes) and for young children. Extended use can cause Hyperthermia. Prolonged immersion in hot water can result in HYPERTHERMIA, a dangerous condition which occurs when the internal temperature of the body reaches a level above normal (98.6°F, 37°C). The symptoms of hyperthermia include unawareness of impending hazard, failure to perceive heat, failure to recognize the need to exit the spa, physical inability to exit the spa, fetal damage in pregnant women, and unconsciousness resulting in a danger of drowning.

 **WARNING** The use of alcohol, drugs, or medication can greatly increase the risk of fatal hyperthermia in hot tubs and spas.

TO REDUCE THE RISK OF INJURY

- The water in a spa should never exceed 104°F (40°C). Water temperatures between 100°F (37.7°C) and 104°F (40°C) are considered safe for a healthy adult. Lower water temperatures are recommended for extended use (exceeding 10 minutes) and for young children. Extended use can cause Hyperthermia.
- Since excessive water temperatures have a high potential for causing fetal damage during the early months of pregnancy – pregnant, or possible pregnant women, should limit spa temperature to 100°F (37.7°C). Consult your physician before using spa.
- Do not use spa directly after strenuous exercise.

AVOIDING THE RISK OF SKIN BURNS

- To reduce the risk of injury, before entering a spa the user should measure the water temperature with an accurate thermometer.
- Test the water with your hand before entering the spa to be sure it is comfortable.

SAFETY SIGN

- Each Aspen Spa is shipped with a SAFETY SIGN in the owner's package. The sign, which is required as a condition of Product Listing, should be permanently installed where it is visible to the users of the spa. To obtain additional safety signs, contact your dealer.

 WARNING
REDUCE RISK OF ELECTROCUTION 1. Install at least 5 feet from water using nonmetallic plumbing. 2. Do not install under spa skirt or within an enclosure that would restrict ventilation. 3. If blower is included, install at least 1 foot above maximum water level.
REDUCE THE RISK OF CHILD DROWING 1. Supervise children at all times. 2. Attach spa cover after each use. 3. Install a suction guard with marked flow rate no less than 170 GPM to avoid hair and body entrapment.
REDUCE RISK OF OVERHEATING 1. Check with a doctor before use if pregnant, diabetic, in poor health, or under medical care 2. Exit immediately if uncomfortable, dizzy, or sleepy. Spa use can cause hyperthermia and unconsciousness. 3. Spa heat in conjunction with alcohol, drugs, or medication can cause unconsciousness.
WHEN PREGNANT , soaking in hot water for long periods can harm your fetus. Measure water temperature before entering. 1. Do not enter spa if water is hotter than 100F (38C). 2. Do not stay in spa for longer than 10 minutes.

Important Spa Instructions

The following contains important spa information, and we strongly encourage you to read and apply them.

IMPORTANT DO'S AND DON'TS

- DO** Use the spa cover when the spa is not in use. Make sure you always lock the child resistant locks after using the spa for your children's safety.
- DO** Follow the Spa Care and Maintenance recommendations stated in this manual.
- DO** Use only approved accessories and recommended spa chemicals and cleaners.
- DON'T** Leave the spa exposed to the sun without water or the vinyl cover in place. Exposure to direct sun light can cause solar distress of the shell material and void the warranty.
- DON'T** Roll or slide the spa on its side. This will damage the siding.
- DON'T** Lift or drag the cover by using the cover lock straps; always lift or carry the cover by using the handles.
- DON'T** Attempt to open the electrical control box. There are no user serviceable parts inside. Opening the control box by the spa owner will void the warranty. If you have an operational problem, carefully go through the steps outlined in the Troubleshooting section. If you are not able to resolve the problem, contact your authorized Aspen Spas dealer. Many problems can easily be diagnosed over the telephone by an authorized Aspen Service Technician.

Electrical Requirements

IMPORTANT: Fill the spa with water before turning on the power.

Your Aspen Spa has been carefully designed to give you maximum safety against electrical shock. Connecting the spa to an improperly wired circuit will negate the warranty and many of the spa's safety features. Improper wiring may also cause electrocution, risk of fire, and other risks of injuries. Please read and follow the electrical installation requirements and instructions for your specific spa model completely!

Please read the following wiring requirements. Aspen Spas would like to ensure our customers and their electricians understand what is expected before your spa arrives.

Important: All spas installed in the US must meet the requirements of the National Electric Code (NEC) and all applicable state and local codes. The electrical circuit must be installed by a licensed electrician and approved by your local building/electrical inspector.

All spas must be permanently connected to the power supply. The power supply is to be dedicated; no other appliances or lights sharing the circuit.

The electrical circuit must be protected with a GFCI disconnect circuit breaker (see spa specifications for proper breaker size). The wiring is to be #6 copper wire with ground. Review electrical diagram below and note that all connections are to be completed only by a licensed electrician.

To connect the spa it is necessary to drill a 1" hole on the ABS plastic base on one of the corners.

A disconnecting means must be provided and located within sight from the equipment and at least 6 feet (1.52 m) from the inside walls of the pool, spa, or hot tub. Check the local codes for exact specifications.

Tips:

- Wire does not stretch, therefore leave extra.
- Insist your electrician uses a Commercial Grade GFCI
- Read the GFCI directions (the neutral wire from the spa attaches to the underside of breaker, not on the neutral buss bar).
- Aspen cannot be responsible for faulty GFCI disconnect breakers.

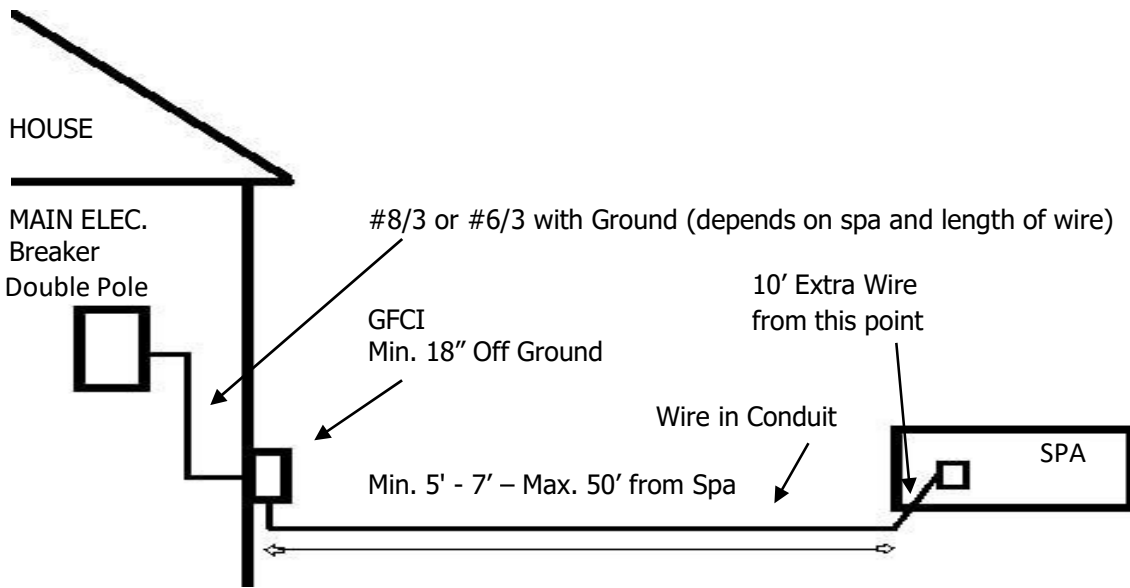

230 VOLT PERMANENTLY CONNECTED MODELS

Aspen Spas must be wired in accordance with all applicable local electrical codes. All electrical work should be done by an experienced, licensed electrician. We recommend the use of appropriate electrical conduit, fittings, and wire for all circuits.

The following two diagrams illustrate how to wire specific spa models:

- Your spa must be connected to a Ground Fault Circuit Interrupter for user and equipment protection.
- The subpanel requires a GFCI disconnect circuit breaker (see spa specifications for proper breaker size), single phase, 230 volt, four wire service (two hot lines, one neutral, one ground). The grounding conductor must not be less than #10 AWG. Refer to local codes and to NEC 250- 122.
- Mount the subpanel in the vicinity of the spa, but not closer than five feet away, in accordance with all local codes. (N.E.C. 680-38 to 41-A-3)

Once your spa has been filled with water, turn it on and test all of the circuit breakers.

IMPORTANT: If both breakers immediately trip, verify that the wires are correctly connected. Each breaker should be tested prior to each use. Here's how:

1. Push the "TEST" button on each GFCI disconnect breaker, and observe it click OFF.
2. Wait 30 seconds, then push the breaker switch to the OFF (down) position (to ensure that it has completely disengaged), then push the breaker switch to the ON (up) position.

If the GFCI disconnect breakers fails to operate in this manner, your spa may have an electrical malfunction, and you may be at risk of electrical shock. Turn off all circuits and do not use the spa until the problem has been corrected by an authorized service agent.

⚠ WARNING: Removing or bypassing any GFCI disconnect breaker will result in an unsafe spa and will void the spa's warranty.

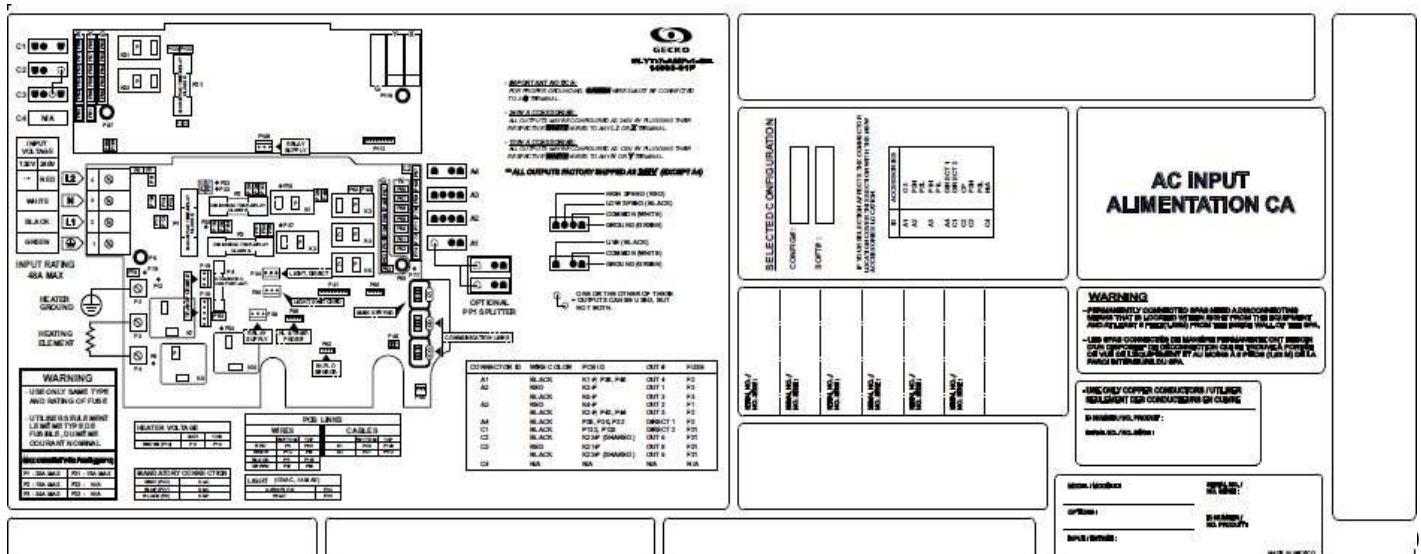

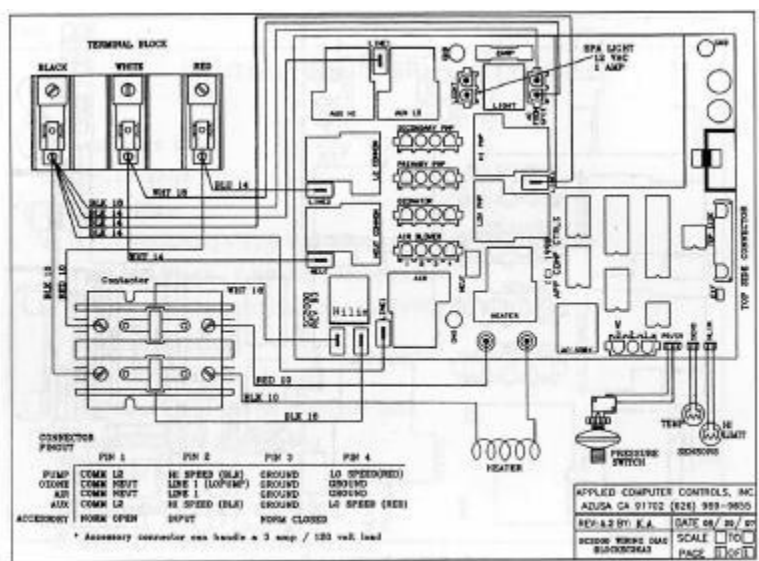
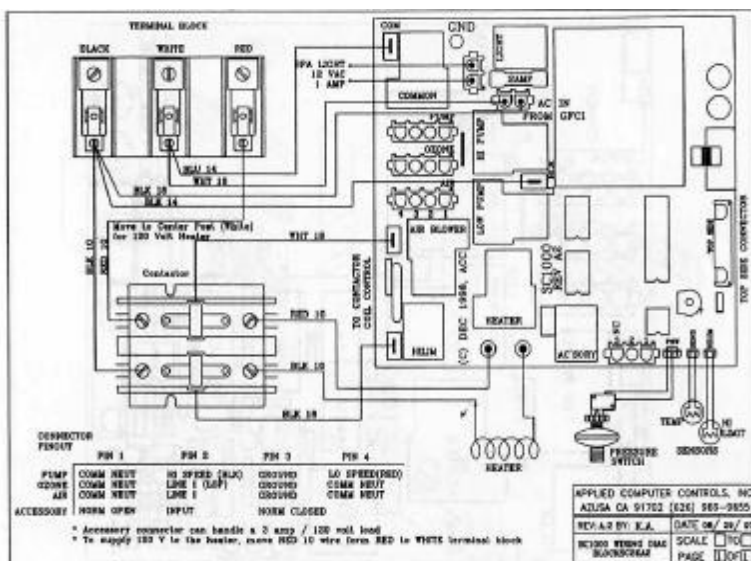
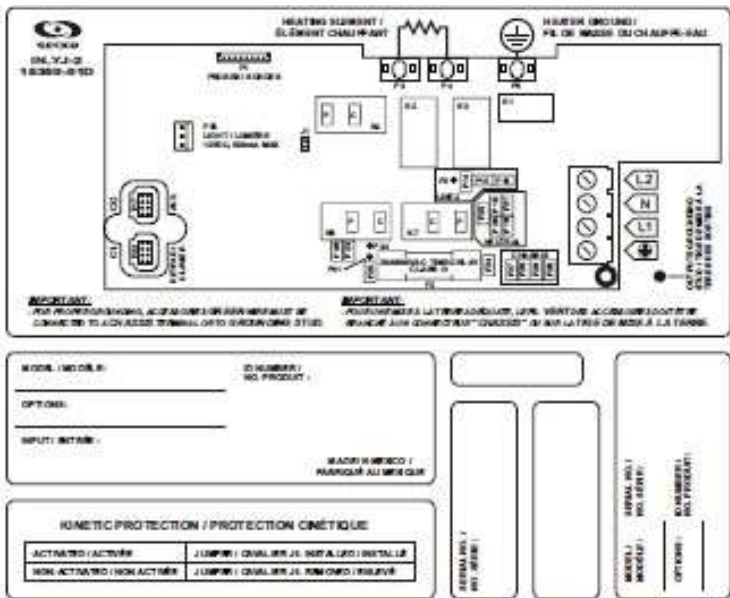
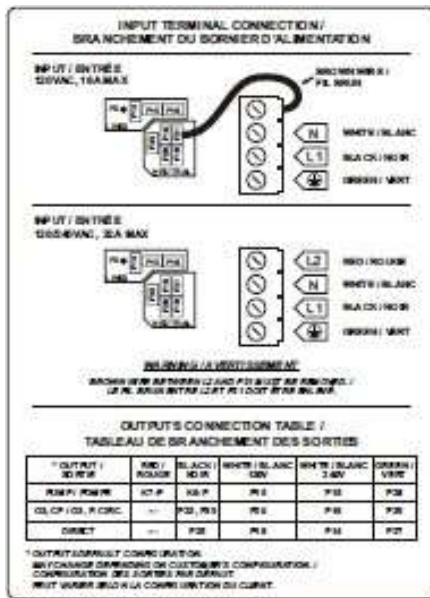
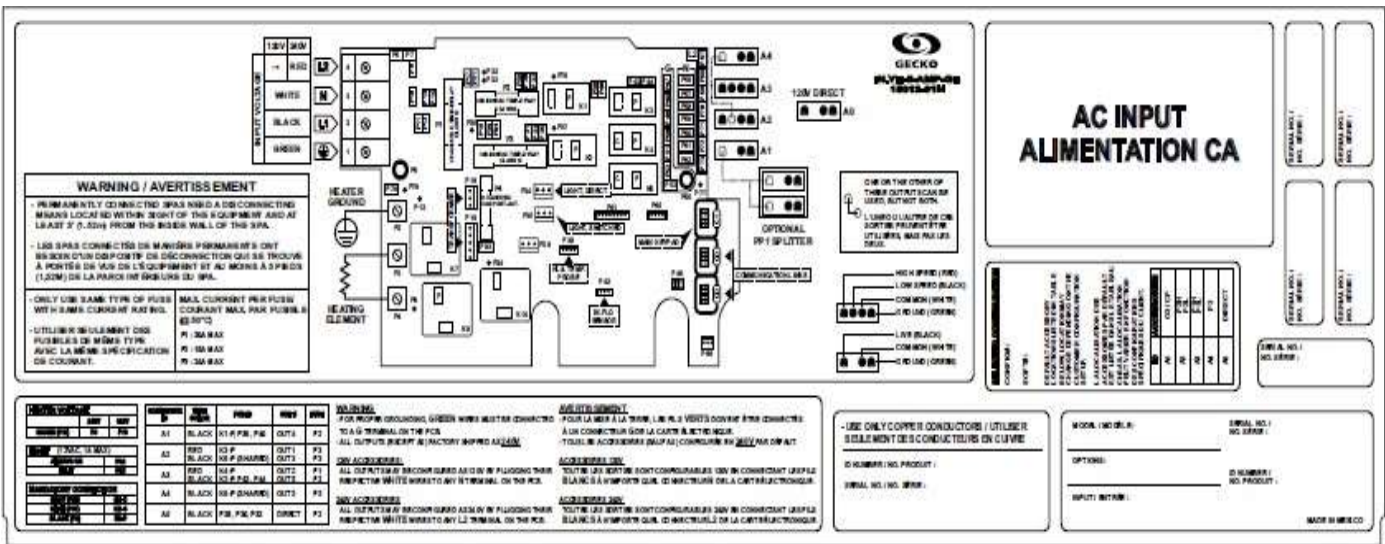

Where Best To Install A Hot Tub

Not sure where to place your hot tub? Read our useful guide created by the Aspen Spas team to help you decide on the best location.

When you're looking to buy a hot tub, one of your first questions you'll be asking yourself will be "Where should it go?" Getting the location of your hot tub just right will help ensure you get years of relaxation and enjoyment. All of our hot tubs and swim spas are designed for above-ground and portable installation, or in-ground, sunken installation – with a few minor modifications. There are obvious benefits in both methods of installation.

Outdoor hot tubs

Hot tubs make fantastic additions to garden patios and decked areas. If you're planning to use your hot tub for a soothing soak on cold, wintry nights then think about installing it near the back door so you don't have far to run when you get out.

If you have a lot of outside space you may want to make a feature of your hot tub with a gazebo enclosure, which can also give you some privacy, depending on your requirements. We have a wide range of colors, sizes, designs and features to choose from and we're happy to discuss all your customization requirements.

Give some thought to the aesthetics of your hot tub and its surroundings. What will your view be when you're relaxing in the tub? Adding landscaping such as flowers, trees and potted plants or even outdoor lighting and music can really enhance the ambience. Your hot tub and its surrounding environment can be personalized to reflect your individual style and taste. A well-positioned sunken hot tubs can feel like a natural part of the garden.

Indoor hot tubs

A hot tub can also be a fantastic feature for an indoor bath or spa room, a gym or even a sun room. First, consider how the spa will get to the desired location. Secondly, spas will always have excessive water spillage and it is extremely important to have proper drainage. Areas around and under your spa can become wet or damp, therefore it's necessary to take proper provisions to protect all structures, furniture, and carpeting that may be affected. Also, indoor installations will need plenty of ventilation to avoid mold and mildew damage from moist, heated air. Finally, the spa must be on a level, non-slip and load-bearing floor. Any potential damage due to water spillage or leakage from the spa is the responsibility of the home owner.

Key points to consider

- Do I want my hot tub be inside or outside?
- How much space will I need?
- Is the surface flat and load-bearing?
- Do I want my hot tub to be in-ground or above-ground?
- Do I want a gazebo or enclosure for my hot tub?

When deciding these factors you will also need to consider ventilation and drainage, as well as water and electrical supplies. When you're measuring the space required, be sure to allow enough space for taking the cover on and off, as well as for installation and servicing.

Location of your Aspen Spa

SAFETY: Check with local electrical codes as they may vary.

Foundation: Don't forget to level your spa before filling it. Because of the combined weight of the hot tub, water and users, it is extremely important that the base you have chosen for your new spa is smooth, flat, level and capable of supporting this weight. If the spa is placed on a surface which does not meet these requirements, damage to the skirt and/or spa shell may result. Damage caused by improper support is not covered under the warranty. It is the responsibility of the owner to ensure the integrity of the support at all times.

ACCESS: SPAS WHICH WILL BE RECESSED INTO A FLOOR OR DECK, MUST BE INSTALLED IN SUCH A MANNER TO PERMIT ACCESS TO THE EQUIPMENT FOR SERVICING Please be sure that there are no obstructions which would prevent removal of the cabinet side panels, especially on the side with the operating equipment.

OUTDOOR INSTALLATIONS: When selecting the most ideal outside location for your spa, please consider the following: The proximity of the spa to your house, especially in cold weather. A clean path that minimizes debris tracked into the spa. A surrounding environment that provides shelter and privacy while considering view obstructions and additional maintenance.

We recommend a reinforced concrete pad at least four inches thick. The reinforcing rod or mesh in the pad should be attached to a bond wire.

DECK INSTALLATIONS: To be certain your deck can support your spa, you must know the deck's maximum load capacity. Consult a qualified building contractor or structural engineer. To find the weight of your spa, its contents and occupants, refer to the spa

specifications given to you by an authorized Aspen Spas dealer. This weight per square foot must not exceed the structure's rated capacity, or serious structural damage could result.

INDOOR/BASEMENT INSTALLATIONS: When considering an indoor spa placement, there are three major issues to think about.

Access: How will the spa get to the desired location? **Drainage:** Spas will always have excessive water spillage and it is extremely important to have proper drainage. Areas around and under your spa can become wet or moist. Take proper provisions to protect all structures, furniture and carpeting that may be affected. The **humidity** will naturally increase with the spa installed indoors.

⚠ WARNING: Please keep the area around your spa well ventilated when it is installed indoors or in a confined area. Inadequate ventilation around the spa could cause a build-up of a higher-than-normal concentration of spa chemicals and/or bacterial fragments. These dispersed spa chemicals and/or bacterial fragments can be inhaled, and may result in breathing difficulties or lung damage in certain people suffering from a compromised immune system or respiratory infection. If you or other bathers are affected by this condition, please seek medical attention as soon as possible.

In addition to the above, properly clean and maintain you spa as follows:

- Follow all procedures in this owner's manual and printed instructions on water care (chemical) products packaging.
- Test the water regularly to ensure proper levels of sanitizers, pH, and other water care requirements.
- Drain, clean, and refill your spa with fresh water on a regular schedule, and in accordance with this owner's manual.
- Clean the filter(s) at least once per month.
- Check to make sure you have proper circulation throughout your spa water system.
- Have spa users bathe before entering the spa water.

Locate your equipment compartment, which houses all the electrical components, in a place where water will drain away from it. Allowing water into the equipment compartment can damage the electronics, or may result in tripping your house's circuit breaker. Leave yourself easy access to the Ground Fault Circuit Interrupter (GFCI) for testing. The GFCI is located at the subpanel of a hard-wired spa.

Never let water get into the subpanel or into the electrical outlet that your spa is hard-wired. Consult your local code authority to determine is an electrical outlet with a cover is required for your installation.

Installation of your Aspen Spa

As well as considering the above when making your site selection, certain restrictions and/or requirements may be required in your locality.

SPA LEVELLING PREPARATION

Concrete sloped at ½ inch (1.3cm) per 10 feet (305cm) is preferred so that rain water and water spillover will run off and not puddle underneath the spa (water under the spa for long periods of time may cause the wood to deteriorate). Other options are brick, stepping stone, or blocks.

It is important to note that soft surfaces, even when stepping stones are used to evenly distribute the weight of the spa, will have a tendency to settle, thus resulting in an unlevelled spa.

NOTE: placing the spa on grass or dirt may increase the amount of debris which is inadvertently brought into the spa water and may cause harm to your equipment as well as spa, which is not covered under warranty. We discourage to place your spa on grass or dirt.

SPA COVER INSTALLATION

- Place the cover squarely on the spa.
- Position the tie-down locks included with your cover on the side of the spa so that they are easily reached by the cover tie-down straps. Allow about ½ inch to ¾ inch (1.3cm to 1.9cm) slack in the straps to make it easy to insert straps into locks and to compensate for vinyl shrinkage in cold water.
- Attach the locks with the screws provided and insert the cover tie-down straps into the locks.

NOTE: Keeping the cover in place any time the spa is not in use will reduce the amount of time the heater operates, thereby minimizing operating costs.

⚠ DANGER - RISK OF INJURY: Never leave a spa uncovered or unattended; never leave a spa cover unlocked; do not stand, sit, or lie on the cover.

DELIVERY ACCESSIBILITY

Doors, halls, stairs, etc. may pose obstructions to deliver your spa to its desired site.

Trees, lawn, placement surfaces, etc. can create extra work in maintaining a clean and safe environment around your spa. Be advised that placing your spa on dirt or grass may increase the amount of debris inadvertently brought into the spa water on the feet or users or by the wind. The intrusion of this debris into the spa water may affect water chemistry and/or operation. It may cause harm to your equipment as well as spa, which is not covered under warranty. We discourage to place your spa on grass or dirt.

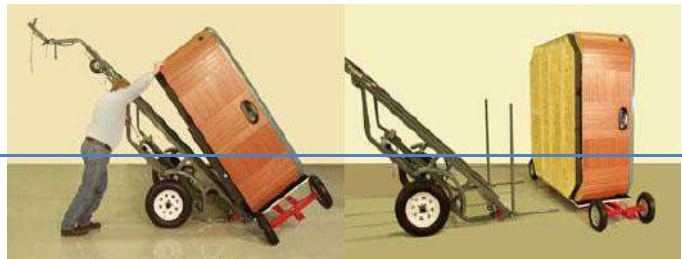

Preparing For Your Hot Tub Everything You Need To Know

Buying a hot tub is exciting but it's important to properly prepare the site so the installation goes smoothly. Let Aspen Spas guide you through it.

A hot tub will need the right location to ensure it runs smoothly. Check out our guide to get you ready for your hot tub delivery.

SAFETY FIRST: It is always best to consider applicable codes and permits. Most cities and boroughs require permits for the installation of electrical circuits or the construction of exterior surfaces; decks, sunrooms, concrete pads, etc. Do NOT place your spa underneath overhead power lines. Contact the codes departments in your area for the parameters you are required to meet. Also, some areas have adopted residential barrier codes, which may require fencing or self-closing gates on the property to prevent children and/or unsupervised, unwanted guests from entering the spa. Your Aspen Spa is complete with a locking thermal cover that meets the ASTM standards for safety covers and as a result, is usually exempt from most barrier requirements. As a general practice, your local Building Department will inform you of any applicable barrier requirements at the time a permit is obtained for the installation of an electrical circuit.

ALL PERMITS ARE THE RESPONSIBILITY OF THE HOMEOWNER.

BASE/FOUNDATION

- Because of the combined weight of the hot tub, water and users, it is extremely important that the base you have chosen for your new spa is smooth, flat, level and capable of supporting this weight. If the spa is placed on a surface which does not meet these requirements, damage to the skirt and/or spa shell may result. Damage caused by improper support is not covered under the warranty. It is the responsibility of the owner to insure the integrity of the support at all times.
- Our hot tubs weigh between 650 to 1000 lb and when filled with water range from 4000 lb up to 7000 lb. A concrete base, at least 4" thick is recommended.
- Paving stones and decking can be fantastic embellishments for your hot tub, but again you will need to ensure the materials can support the weight of the tub, especially when using elevated decking.
- Check out our comparison chart for the specifications of all the hot tubs we sell.

WATER SUPPLY

- You will need to ensure that your hot tub is located near a water supply; it's as easy as using a garden hose to fill it up.

HIRE AN ELECTRICIAN

- You will need to hire a fully qualified electrician to ready your main supply in order to keep the power safe and secure to your hot tub - **do not try to prepare the power supply yourself.** This will also ensure your warranty is not compromised.
- The hot tub will need its own electricity supply, so an electrician will install a disconnect circuit breaker in your main panel, run the wire to a GFCI disconnect, which then has to be directly connected to the hot tub. The electrical supply required will depend on the model you have chosen, but our range of products will usually require a 30 AMP to 50 AMP (see spa specifications).
- It is best to have the GFCI disconnect outside, not in your main circuit breaker panel. Consult your local electrical codes for specific distances and requirements.

Pre-Delivery Information

OUTDOOR INSTALLATIONS

Your spa must be sited on a solid, flat, level base which is the same size or larger than the spa. The base can be either a 4" concrete slab or suitably strengthened (at least 12" -16" centered joist) timber decking or existing patio area assuming it has suitable foundations of hardcore as opposed to sand. Whatever base area is chosen, it must be of suitable load bearing capacity. The spa must not be sited on bare dirt or grass, as there is a risk of settling or subsidence. Please ensure your base has suitable drainage.

You should also consider seasonal changes when siting your spa. For example, siting your spa under trees may look nice in the summer and provide plenty of privacy, but come autumn, you may find it difficult to keep your spa clean and come winter, you may lose your privacy.

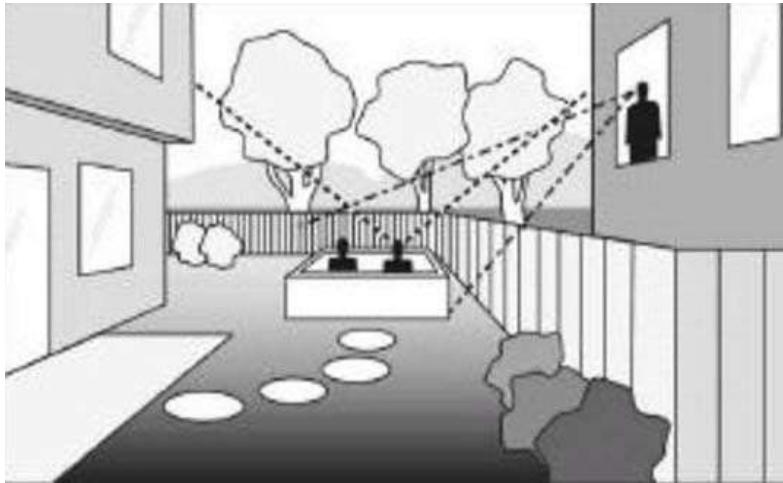

For many people, privacy is an important factor if it poses a problem for you, you may wish to consider a pergola or gazebo. Many of our customers have found either is ideal for privacy and as a changing facility for all year round use.

INDOOR INSTALLATIONS

If you have decided to site your spa indoors, it is important to ensure that the floor is of a suitable load bearing capacity to carry the weight of spa, water and occupants. The floor should be level and not be adversely affected by water. Carpeted or laminate floors are not suitable. A non-slip ceramic tiled floor is ideal.

Ensure that there is plenty of ventilation to prevent moisture affecting your walls and ceiling. You may wish to consider purchasing a suitable de-humidifier to assist in this process and this is especially recommended if siting your spa in a log cabin or similar structure. Also, remember that your spa will require emptying every 12 to 14 weeks so there will need to be suitable drainage facilities nearby in order to empty your spa from the drain valve, located at the base of one side of your spa.

A minimum of 3' of clear access is required for servicing on at least two sides of the spa, should access be required for service work to be completed, Aspen Spas holds no responsibility for the drainage, removal or refilling of the spa. Depending on which model you have purchased, pumps and other serviceable components will be located on one or two sides of the spa. Check with your supplier for clarification on your model.

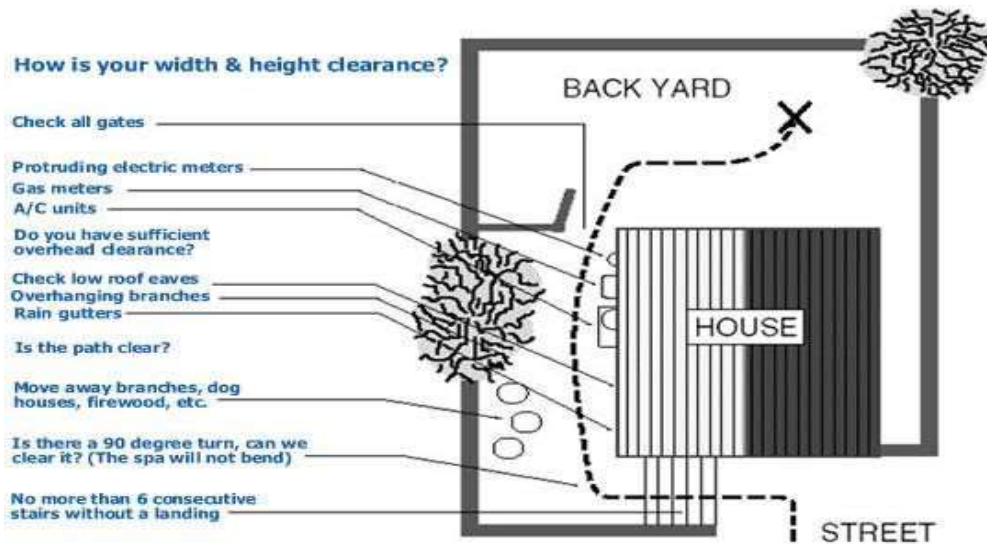

WATER

The best means of filling your spa is with a garden hose. Please ensure that you have one readily available. If you are aware that your water pressure is poor, we should be advised prior to delivery. The design of our spas allows for easy drainage, again, using the hose which conveniently fits onto the drain valve situated at the base of your spa.

Ideally, you should empty the water to a nearby drain.

You may wish to purchase a suitable submersible pump to speed up this process. Your Aspen Spa dealer will be able to advise you on a suitable model.

DECKING AROUND YOUR ASPEN SPA

Ensure that you are aware of the above measurements. Always consider during your planning that any decking boards and supporting beams that you install allow access to the sides of your Spa. It is the customers' responsibility to ensure that any decking is clear of these areas prior to any visit by our technicians. If you are unsure then please ask before construction.

Spa Start Up

BEFORE YOU FILL YOUR SPA

- DO** Make sure your spa has been properly installed per all local codes; this includes the location of the spa, the foundation of the spa as well as the electrical installation of the spa.
- DO** Before filling your spa for the first time, remove the equipment compartment door and check to ensure that the unions on either side of the pump(s) and heater are hand-tight.
- DON'T** Power up the spa until it has been filled with water. Power to the spa automatically activates critical components within the spa, such as controls, heater, and other systems. If power is supplied to these components prior to the spa being filled, the components will be damaged, and this may result in a non-warranty component failure.
- DON'T** Fill the spa with hot water, as tripping of the high-limit thermostat may result.
- DON'T** Use your spa after filling until all of the steps listed below are completed.

STARTING UP YOUR ASPEN SPA

- Close all drains, remove the filter(s). Clean any debris inside spa. Place hose in filter housing and begin filling. Do NOT fill your spa with water from water softener. If your water is extremely hard, you will need to treat it before beginning your chemical process (see chemical reference book). You may also want to consider getting your water from another source.

- Fill spa until water cover all jets (one inch above the highest jet in the spa). Caution, do not overfill spa. Reinstall the filter and then the skimmer basket, and weir once the spa is filled.

After The Spa Has Been Filled

- Turn the power on to the spa at the GFCI disconnect breaker. After initial programming sequence, your heater and filter systems will begin automatically.
- To check the operation of the jet system and to purge any remaining air from the heating system, push the "JETS" button on the control panel 2 times to run the jet pump(s) on high speed for one minute. Once the jet system is fully operational (as indicated by strong, non-surging jets), priming of the spa is complete. If you do not feel a steady stream of water from our jets, refer to the instructions for priming the pump in the SPA TROUBLESHOOTING section in the back of this manual.
- Regular filtration is essential for proper maintenance of your Spa. If your spa is equipped with a 24-hour circulation pump, filtration is on automatically and requires no attention. Spas NOT equipped with a 24-hour circulation pump, you must set desired amount of filtration. Run your spa for a minimum of 8 hours a day. Spas are programmed at the factory but adjustments may be needed depending upon your spa size and usage.
- Refer to the Spa Equipment Control section of this manual for additional information on how to control your spa.
- Set the temperature control to the desired temperature between 100°F (37.7°C) and 104°F (40°C), then place the spa cover on the spa and allow the water temperature to stabilize (approximately 12 hours). Make sure you secure the cover in place using the cover locks. Periodically check the spa water temperature. When the water temperature climbs above 90°F (32°C), proceed to the next step. The spa temperature is pre-programmed to reach 100°F (37.7°C) and will normally do so within 8 to 12 hours.
NOTE: Setting the temperature higher on your Top Side Control Panel does NOT accelerate the heating process. The heater will run until set temperature is reached and turns itself off.
- Using a test strip and applicable chemicals adjust Total Alkalinity (TA) to 80-120 ppm, Calcium Hardness (CH) to 50-150 ppm, then spa water pH to between 7.2 and 7.8. These procedures are listed in the "Water Quality and Maintenance" section.
Operation note: Adjusting the Total Alkalinity as the first step is important, as out-of-balance TA will affect your ability to adjust the pH correctly and will prevent the sanitizer from operating effectively.
- Recheck the Total Alkalinity (TA) 80-120 ppm, Calcium Hardness (CH) 50-150 ppm, then spa water pH at between 7.2 and 7.8.

PRIMING THE PUMP

Every so often after a spa is drained and refilled you may experience what is called an "air lock". You will hear the pump running but there will be no activity from the jets operated by this pump. This is a sign that the pump is not properly primed.

To correct this situation, please perform the following:

1. Turn off the power to the spa.
2. Remove the cabinet panel in front of the equipment.
3. Turn the power back on to locate the correct pump that has an air lock.
4. Turn the power back off.
5. Locate the drain plug on the front of the correct pump and loosen it to allow the air to escape. You may hear some air releasing, or a small amount of water may escape. Hand tighten the plug.
6. Turn the power back on and activate the pump to be sure that the jets are working at full speed and then tighten the plug to insure that it will not leak. Loosening and tightening the plug may require small pliers. DO NOT OVER TIGHTEN. PLUGS WILL BREAK OFF.
7. Reinstall the cabinet panel and adjust the Top Side Control display for day and time.

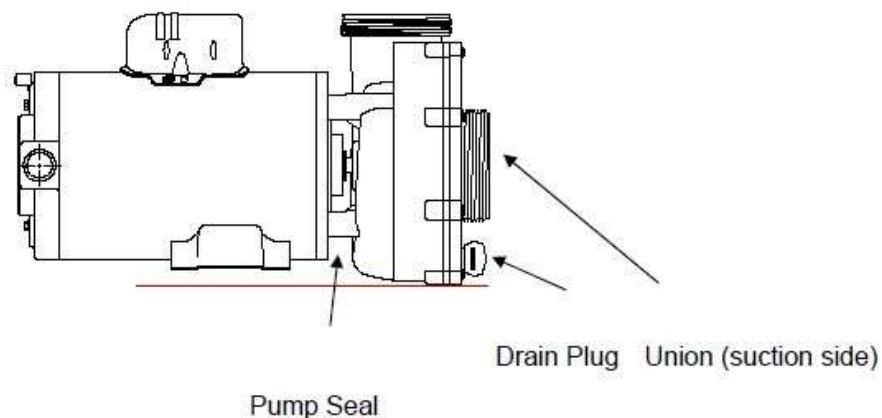

Maintenance

Is it difficult to maintain a spa?

No, it's not difficult to maintain a hot tub. It does require some attention, but on average it only requires approximately 10 minutes/week. There are times where you will want to soak and clean the filters or drain and refill the spa and they do take more time, but on average it does not require a lot of time.

What regular weekly and monthly maintenance is required?

- Two to three times per week you will want to oxidize/shock the water, if necessary.
- Twice a week you will want to check the **sanitizer**, pH and Alk **levels**, rinse the filters and condition the water with clarifier.
- Monthly, you will need to soak and clean the filters with a filter cleaner.

What quarterly and annual maintenance is required?

- Quarterly, you will want to drain and refill the spa **and test the GFCI. It is best to** condition the cover at this time with a proper vinyl protectant, like Aerospace 303.
- Annually, you will want to flush or purge the spa and the internal plumbing. **It is also recommended to open up the front panel (where the spa pumps and equipment is located) and perform a visual inspection, checking for any damage, water stains, or signs of insect and other pest. Identifying any and all potential issues early will not only protect the spa, but save you money over the life of the spa.**

How do I add chemicals to my spa?

Most of the chemicals are powders or liquids and are simply added by pouring into the spa water. There are copper/silver sanitizers that are installed inside the filter basket, which are good for 4 months. It's best to leave the cover open when adding chemicals to the spa water to preserve the underside of the spa cover.

How do I change and clean filters?

The filters in spas are asked to do a lot when you take into consideration the amount of water per bather that is being filtered.

- We recommend cleaning the filter two times per month when the spa is being used regularly. It is also advisable to keep a spare so that you can always insert a clean filter into the spa while cleaning the dirty one.
- Filters are easy to change. You simply need to pull up the filter face, remove the basket and unscrew the filter. It's best to do this when the spa is not filtering, which creates downward pressure on the filter and much harder to remove.
- Filters work best if they are rinsed weekly and soaked monthly in a filter cleaner. Before soaking in cleaner, rinse briskly, then use a 5 gallon bucket, mix up a water and filter cleaner per instructions on the bottle and soak. It can sit as little as an hour or you can leave overnight. Rinse well before reinstalling the filters.
- The life of filter is approximately 1 year. It depends on spa use and regular maintenance. Filters are paper and will break down over time and not be as effective.



How do I drain my spa?

- Your spa should be drained every 3-6 months depending upon variables including usage, bather cleanliness, and attention of water maintenance. When your water seems to be unresponsive to normal chemical procedures, it's probably time to change.
 1. Before draining, for best results, add Spa System Flush to spa water.
 2. Run on high speed through 4-5 cycles and on low for 12-24 hours.
 3. Turn power off at outside GFCI breaker.
 4. Drain water down to foot well. To prevent an air lock, we suggest that you do not drain below the intake suction fittings. Most Aspen Spas are equipped with a built in drain.
 5. Wipe down surface of spa with an acrylic cleaner.
 6. Reinstall drain cap.

Always refill the spa BEFORE restoring power to it.

After the spa has been refilled, follow chemical-start up instruction.

- On most Aspen Spa models, there is an external drain fitting **installed low**, on the outside of the spa cabinet.

- You can also use portable sump pump or siphon the water out using a hose.
 - Helpful hint: while the spa is running, place the hose where you want to drain the water and the other end over a jet. That will fill the hose with water and it will continue to siphon, push the hose to the bottom of the spa and now power off the spa at the GFCI disconnect breaker.

How do I maintain my hot tub's cover?

A cover will protect your hot tub in all types of weather, so proper care will ensure your cover is efficient and will last longer. *It is highly recommended that you install a Cover Lift on your spa for ease of use and protection of your Spa Cover.*

- Always cover spa when not in use and secure cover using straps and clips. This will discourage uninvited guests and children from entering your spa. Cover locks will help prevent wind damage and act as a deterrent, but are no guarantee to prevent access to your spa.
- It is important to maintain good water chemistry to prolong the life of your spa cover. Always fully open your cover when adding chemicals and allow 15-30 minutes for the fumes to disperse before putting the cover back on.
- A good brushing and hose-down will suffice between cleanings, but covers should be cleaned thoroughly at least twice a year.
- To clean the outside of your cover, use a specialty spa-cover cleaning product such as 303 Protectant or a mild dishwashing soap. Do Not use Armor All on your cover's vinyl because it contains alcohol and will tend to crack the material.
- If it is necessary to clean the inside of your cover, remove the foam inserts (requires 2 people and take care not to tear the plastic or zipper) and rinse them down with a mild 1-10 water/bleach solution, hose it off and let it dry before turning it face down to the water.
- If the Styrofoam shows signs of sagging in the middle, it can easily be reversed and turned upside down. This requires two people to prevent damage to the plastic covering and take caution with the zipper so it doesn't become bound up or tear away from the vinyl.
- Heavy snow and ice should be brushed off the cover and not allowed to accumulate. Not attending to snow and ice can cause covers to sag and collect water.
- If possible, do not place spa under roof overhangs which do not have a gutter since run-off water will shorten the life of your cover.
-

How do I maintain my cabinet?

The exterior of your Aspen Spa cabinet is made from a high strength material that has exceptional resistance to moisture, corrosive substances, insects and other environmental stresses. It does not absorb moisture, so it will never rot, splinter or crack. Clean with a mild detergent soap solution and wipe dry.

How do I maintain my acrylic surface?

You may clean the surface of your spa with a soft damp cloth. A mild detergent or glass cleaner works well, as well as a mild 1:10 bleach/water solution. There are times when it may be better to use an acrylic cleaner and polish. We do not recommend the use of any type of abrasive cleaner.

⚠ WARNING: Leaving your spa uncovered for an extended period of time in direct sunlight exposure and high temperatures may cause permanent damage or discoloration. We recommend that you keep your spa full of water and covered when not in use.

How do I maintain my spa pillows?

A mild soap and warm water works best in cleaning your spa pillows. Always rinse the pillows off thoroughly after applying any type of soap to be sure that no residue remains.



Replacement Insert – 01D002
 Replacement Ergonomic Pillow Grey FIC-0012GRY
 Replacement Ergonomic Pillow Charcoal FIC-0003CHA

What is a spa “flush” or “purge” and how do I do it?

Over time, spas and the internal plumbing develop a buildup of bacteria, algae, and biofilm. Therefore it is recommended to annually flush or purge your spa. Basically it is a deep cleansing of the entire spa and plumbing, resulting in a safer, cleaner spa, which extends the life of your spa and spa equipment and allows you to use less chemicals.

- Open cover completely, remove filters and headrests.
- Add 4/5 of Spa Flush and run jets on high for at least 4-5 cycles.
- If possible, set spas to filter on low for another 4–8 hours.
- Before draining spa, turn the pumps on high for another 1-2 cycles.
- Shut power off and drain the spa.
- Clean the spa when empty (use remaining 1/5 of Spa Flush to wipe down the spa)

- We recommend a rinse cycle: fill spa, add 4 cups of liquid chlorine bleach, and run jets for 30–45 minutes, then empty the spa.
- Fill spa using Pre-Filter, which attaches to the end of your hose.
- Insert new or very clean filters.
- Adjust alkalinity & pH & hardness.
- Add your desired sanitizer.
- Add 1-2 oz. of non-chlorine Shock twice a week, as necessary.

Can I winterize my hot tub?

Yes, you can winterize your spas if you do not think you are going to use the spa during the winter months, however **IT IS NOT RECOMMENDED BY ASPEN TO DO SO! If the spa is not properly winterized and all the water is removed, pipes, unions, pump wetends and other component can crack, even when the slightest of water is left in the lines. Also, pump seals, union gaskets/orings, jets gaskets, silicone seals and other component can dry up and leak when the spa is winterized. The warranty, parts and labor, will be voided from improper winterization.**

If you choose to winterize your spa, please follow the following steps.

- Turn the heat all the way down and then power off the spa at the GFCI disconnect breaker.
- Remove the filter(s) and clean thoroughly and store in a dry place. Remove the pillows as well and store for the winter.
- Drain the spa completely through siphoning or the drain on the spa and remove any access water inside the spa shell.
- Remove the front panel of the spa, this is the access panel where all the pumps and equipment are located.
- Detach the unions to the pumps, heater, blower and any other equipment the spa may have.
- Use a shop vac to remove any water in the lines that you just detached from the spa equipment, including the spa drain line as well.
- It is also recommended to blow air through the lines to remove any additional water that is not removed by the shop vac.
- Use a non-toxic pool/spa antifreeze and a funnel to pour down all the jets fittings, filter housing and suction.
- Install the cover back on the spa and make sure it securely fastened so no water can get into the spa during the winter months.
- It is also recommended to cover the spa and spa cover with a spa cover protector or waterproof tarp to protect it from snow and ice.

If you do not want to personally winterize your spa, but still want to winterize it, please contact your local Aspen dealer.

Water Quality

BASIC INFORMATION

It's important to have clean water. Water maintenance is one of the least understood, yet most important, areas of spa ownership. Your dealer can guide you through the process of achieving and maintaining perfect water in your spa, given your local conditions. **IMPORTANT:** Water Terminology can be found at the end of this section.

- **Always read & refer to the owner's manual** for complete information.
- **Test your water** with a test strip once a week, or each time the spa is used.
- **Add chemicals** in frequent small amounts to prevent overdosing the spa.
- **Use the spa only** when the chlorine level is between 1-5 ppm or manually add chlorine as needed.
- **It is the spa owner's responsibility** to prevent over or under chlorination.

IMPORTANT: Remember to change your water every three to four months.

Check with your Aspen Spas dealer to determine if water in your region has unique qualities - such as high metal or mineral content - that should be addressed. Your program will depend on your water's mineral content, how often you use your spa, and how many people use it.

WATER QUALITY CHART

PARAMETER	TARGET	MIN - "OK" RANGE - MAX	
pH	7.4	7.2	7.6
ALKALINITY	80 ppm	40 ppm	120 ppm
HARDNESS	100 ppm	50 ppm	150 ppm
CHLORINE	3 ppm	1 ppm	5 ppm

CHEMICAL SAFETY

When using chemicals, read the labels carefully and follow directions precisely. Though chemicals protect you and your spa when used correctly, they can be hazardous in concentrated form. Always observe the following guidelines:

- Allow only a responsible person to handle spa chemicals. Keep them out of the reach of children.
- Accurately measure the exact quantities specified, never more. Do not overdose your spa.
- Handle all containers with care. Store in a cool, dry, well ventilated place.
- Always keep chemical containers closed when not in use. Replace caps on their proper containers.
- Don't inhale fumes, or allow chemicals to come in contact with your eyes, nose, or mouth. Wash your hands immediately after use.
- Follow the emergency advice on the product label in case of accidental contact, or if the chemical is swallowed. Call a doctor or the local Poison Control Center. If a doctor is needed, take the product container along with you so that the substance can be identified.
- Don't let chemicals get on surrounding surfaces or landscaping. Don't use a vacuum cleaner to clean up chemical spills.
- Never smoke around chemicals. Some fumes can be highly flammable.
- Don't store any chemicals in the spa equipment compartment.

HOW TO ADD CHEMICALS TO MY SPA

Most of the chemicals are powders or liquids and are simply added by pouring into the spa water. There are copper/silver sanitizers that are installed inside the filter basket, which are good for 4 months. It's best to leave the cover open when adding chemicals to the spa water to preserve the underside of the spa cover.

IMPORTANT: After administering a super chlorination treatment or non-chlorine shock to your spa, leave the cover open for a minimum of 20 minutes to allow the oxidizer gas to vent. A high concentration of trapped oxidizer gas which may exist as a result of the shock treatment (not daily sanitation) may eventually cause discoloration or vinyl degradation to the bottom of the cover.

This type of damage is considered chemical abuse and is not covered under the terms of the limited warranty.

FUNDAMENTALS OF WATER MAINTENANCE

- **Testing:** Test the water weekly or each time the spa is used with convenient 5-way test strips. Critical parameters: Free Chlorine, Total Chlorine, pH, Calcium Hardness (CH), and Total Alkalinity (TA). Store test equipment in a dark, cool, dry place to maintain potency.
- **Water Filtration:** Regularly inspect and clean filters for peak performance.
- **Chemical Balance/pH Control:** It is important to adjust the primary water parameters (Total Alkalinity, Calcium hardness, pH) into the recommended ranges so that they are stabilized or balanced. Balance the water chemistry every time you fill the spa with new water and then during the life of that body of water. Keeping the water in balance prevents damage by holding the pH in a safe range and preventing calcium scale formation on spa equipment. A low pH can damage metal components whereas a high pH can cause high levels of calcium to form scale. Your dealer should provide a detailed water chemistry orientation soon after your new spa is filled for the very first time.
- The following three water components must be kept in balance to avoid damage to the spa. Do balance these components in the order they are listed here as each will help you balance the next using a minimum amount of chemicals.
 1. Calcium Hardness (CH) – CH is the measure of the amount of dissolved calcium in the water. Low levels can make the water corrosive and high levels cause scale formation of spa components. The recommended CH reading is between **50 - 150 ppm**. If the CH level is too low, raise it with Proteam Calcium Up. Once in balance, the CH reading normally remains stable until new water is added.
 2. Total Alkalinity (TA) - TA is a measure of the water's ability to resist changes of pH or buffer capacity. A low TA allows the pH to fluctuate easily. The recommended TA reading is between **80 - 120 ppm**. To raise the TA, use Alkalinity Up (sodium hydrogen carbonate). To lower the TA, use sodium bisulfate. Once the TA is balanced, it normally remains stable until the next drain/ refill. We recommend you check the TA reading at least once per month. Raising/lowering the TA may cause the pH readings to fluctuate widely. Ignore the pH readings on the test strip while you are balancing the TA.
 3. pH - The pH is the measure of the acidity and alkalinity. Maintaining the proper pH level will optimize the effectiveness of the sanitizer, preventing damage to the spa and physical discomfort for spa users. A low pH dissipates sanitizer, causes corrosion, and irritates spa users. A high pH level will neutralize sanitizer, promote scaling and cloud water. The recommended pH reading is between **7.2 - 7.6**. To lower the pH level, use pH Decreaser (sodium bisulfate). To raise the pH level, use pH Increaser (sodium carbonate).
- **Water Conditioners:** Spa fill water varies from location to location and user to user, therefore it is important to consult with your dealer for an appropriate program.
- **Oxidizers:** Ozone and Monopersulfate (MPS) are oxidizers used to prevent the buildup of contaminants, maximize sanitizer efficiency, minimize combined chlorine, and improve water clarity. They are to be used in conjunction with EPA registered sanitizers. Oxidizing Shock is a granular oxidizing chemical.
- **Sanitizers:** Maintaining the recommended residual level of an EPA registered sanitizer at all times will decrease the occurrence of unsafe bacteria and viruses in your spa water. The recommended Free Available Chlorine (FAC), the amount of available chlorine sanitizer, is **3.0-5.0 ppm**. A low FAC can allow bacteria and viruses to grow rapidly in the warm water, and a high FAC can cause discomfort to the user's eyes, lungs, and skin. Each sanitizer carries its own instructions regarding how much to use and when to add it to the spa water.

Vacation Water Care Instructions

If you plan to be away from home, follow these instructions to ensure that the water quality of your spa is maintained:

SHORT TIME PERIODS (3-5 DAYS):

1. Adjust the pH by following the instructions outlined in the Water Quality and Maintenance section.
2. Sanitize the water by following the shock procedures also listed in the Water Quality and Maintenance section.
3. Lock your cover in place using the coverlocks.
4. Upon your return, sanitize the water by following the shock procedures, and balance the pH.

LONG TIME PERIODS (5-14 DAYS):

Prior to leaving:

1. At least one day before you leave, set the temperature to its lowest level. This setting should represent an approximate water temperature of 80°F (27°C)

IMPORTANT: Spa water oxidizers such as sodium dichlor (chlorine) maintain their level of effectiveness substantially longer in warm water 80°F (27°C) than in hot water 101°F to 104°F (38°C - 40°C).

2. Adjust the pH as required. Sanitize the water by following the shock procedures.

Upon your return:

3. Sanitize the water by following the shock procedures. Return the set temperature to its original setting. The spa water will be safe for you to use once the Free Available Chlorine residual level has dropped below 5.0 ppm.

IMPORTANT: If you will not be using your spa for an extended period of time (in excess of 14 days) and an outside maintenance service (or neighbor) is not available to assist with the water maintenance, draining or winterizing of the spa is recommended. Spas equipped with our ozone system can extend this to 4 weeks.

The ozone system does not guard against possible freezing damage, however.

Water Care Troubleshooting

CLOUDY WATER

Possible Cause: Dirty Filters.

Solution: Clean filters with Filter Cleaner

Preventative Maintenance: Clean/Soak filters in Filter Cleaner or Degreaser monthly.

Possible Cause: Excessive oils/organic matter.

Solution: Shock spa with oxidizing shock. Add a clarifier to coagulate the organics. Rinse Filter. If necessary, you will need to add a dose of sanitizer.

Preventative Maintenance: Set up a bi-weekly routine of oxidizing shock and clarifier.

Possible Cause: Suspended particles/ organic matter.

Solution: Run jet pump(s) and clean filters with Filter Cleaner!

Preventative Maintenance: Clean/Soak filters in Filter Cleaner or Degreaser monthly.

Possible Cause: Overused Water or TDS (Total Dissolved Solids) are too high.

Solution: Drain, clean and refill the spa. (if it's not below freezing!)

Preventative Maintenance: Remember to drain and refill every 90-120 days.

MUSTY ODOR / ALGAE GROWTH

Possible Cause: High pH or low sanitizer level

Solution: Shock spa with oxidizing shock, add sanitizer, and adjust pH to recommended range; keep the cover open and power the pumps/jets to help oxidize the chlorine.

Preventative Maintenance: Maintain pH and sanitizer levels more carefully.

CHLORINE ODOR

Possible Cause: Low pH, too much chlorine, or high TDS.

Solution: With the cover up and the jets on to help oxidize the chlorine with oxidizing spa shock and adjust pH with to recommended range

SCUM AROUND WATERLINE

Possible Cause: Buildup of oils and dirt.

Solution: Wipe off scum with a rag or non-abrasive pad. If severe, drain the spa. Use a non-soapy tile and vinyl cleaner to protect the spa shell, and refill the spa using normal procedure. If deciding to drain the spa, consider flushing your spa to deep cleanse the spa and the internal pipes.

EXCESSIVE FOAM

Possible Cause: Buildup of body oils, cosmetics and detergents from bathers

Solution: Add Defoamer and Shock. You may want to consider floating type sponge to absorb contaminates. (Keep in mind, if you use defoamer consistently, you will need to drain your spa more frequently)

Preventative Maintenance: Use Oxidizing Shock twice a week to oxidize unwanted organic material.

Possible Cause: Calcium hardness too low

Solution: Add Calcium Hardness to obtain 150-400 ppm calcium level in the water.

Preventative Maintenance: When adding make-up water or freshly filling the spa, have the calcium level tested.

Possible Cause: Large amount of TDS (Total Dissolved Solids)

Solution: Drain and refill water. (ONLY IF IT'S ABOVE FREEZING!)

Preventative Maintenance: Drain and refill water at least once every 90-120 days and replace your silver ion cartridge.

Possible Cause: Dissolved copper or iron in spa water

Solution: Add metal removing agents to sequester minerals in the water or add Metal Magic to remove the metals from the water. (Rinse filters 4 days after using metal magic). Check pH level.

Preventative Maintenance: Test pH and total alkalinity and maintain proper levels. metal removing agents should be used each time the spa is filled.

Using More Sanitizer

Often this means that your Ozone Purification System has expired. Just like with your town's water, without a functioning ozone system, more chlorine is needed. Like theirs, your Hot Tub's system has a limited lifespan. Call your local Aspen Dealer if you need to replace your Ozonator.

You may also need to replace your copper/silver ion cartridge if it's been more than 4 months. The copper/silver ion cartridge works together with the ozone system to keep your water crystal clear, reducing the need for chemical additives.

EYE IRRITATION

Possible Cause: Low pH or low sanitizer level.

Solution: Adjust pH and shock spa with sanitizer.

Preventative Maintenance: Use Oxidizing Shock twice a week to oxidize unwanted organic material and maintain proper sanitation levels

SKIN IRRITATION/RASH

Possible Cause: Unsanitary water, which may be the result of insufficient oxidizing shock. Or the free chlorine level is above 5 ppm.

Solution: Shock spa with oxidizing shock and increase sanitizer level. Allow free chlorine level to drop below 5ppm before spa use. Clean filters with filter cleaner, not just a rinse.

*Preventative Maintenance: Use Oxidizing Shock twice a week to oxidize unwanted organic material and maintain proper sanitation levels. *** If you are uncertain about the sanitary condition of the water, it is best to flush or purge the spa, drain it and start over with new water. Always clean your filter at this time.*

STAINS

Possible Cause: Total Alkalinity and/or pH too low. Or High iron or copper in source water.

Solution: Adjust total alkalinity and/or pH to recommended levels. Use metal removing agents to remove the metals in the source water (remember to rinse filters 4 days later) or use stain and scale to sequester the metals.

Preventative Maintenance: Test pH and total alkalinity and maintain proper levels. Metal removing agents should be used each time the spa is filled.

SCALE

Possible Cause: Total Alkalinity and/or pH too high. High calcium in water.

Solution: Adjust total alkalinity and/or pH to recommended levels. If scale requires removal, add metal removing agents to the spa water, run it overnight, drain the spa, scrub off the scale, clean shell with non-soapy cleaner and refill the spa.

Preventative Maintenance: Test pH and total alkalinity and maintain proper levels. Metal removing agents should be used each time the spa is filled.

Spa Water Maintenance Troubleshooting Guide

SPA WATER MAINTENANCE TROUBLESHOOTING GUIDE		
Problem	Probable causes	Solutions
Cloudy Water	<ul style="list-style-type: none"> • Dirty filters • Excessive oils / organic matter • Improper sanitization • Suspended particles / organic matter • Overused or old water 	<ul style="list-style-type: none"> • Clean filters • Shock spa with sanitizer • Add sanitizer • Adjust pH and/or alkalinity to recommended range • Run jet pump(s) and clean filters • Drain and refill the spa
Water Odor	<ul style="list-style-type: none"> • Excessive organics in water • Improper sanitization • Low pH 	<ul style="list-style-type: none"> • Shock spa with sanitizer • Add sanitizer • Adjust pH to recommended range
Chlorine Odor	<ul style="list-style-type: none"> • Chloramine level too high • Low pH 	<ul style="list-style-type: none"> • Shock spa with sanitizer • Adjust pH to recommended range
Musty Odor	<ul style="list-style-type: none"> • Bacteria or algae growth 	<ul style="list-style-type: none"> • Shock spa with sanitizer—if problem is visible or persistent, drain, clean and refill the spa
Organic buildup / scum ring around spa	<ul style="list-style-type: none"> • Build-up of oils and dirt 	<ul style="list-style-type: none"> • Wipe off scum with clean rag – if severe, drain the spa, use a spa surface and tile cleaner to remove the scum, and refill the spa
Algae Growth	<ul style="list-style-type: none"> • High pH • Low sanitizer level 	<ul style="list-style-type: none"> • Shock spa with sanitizer and adjust pH • Shock spa with sanitizer and maintain sanitizer level
Eye Irritation	<ul style="list-style-type: none"> • Low pH • Low sanitizer level 	<ul style="list-style-type: none"> • Adjust pH • Shock spa with sanitizer and maintain sanitizer level
Skin Irritation / Rash	<ul style="list-style-type: none"> • Unsanitary water • Free chlorine level above 5 ppm 	<ul style="list-style-type: none"> • Shock spa with sanitizer and maintain sanitizer level • Allow free chlorine level to drop below 5 ppm before spa use
Stains	<ul style="list-style-type: none"> • Total alkalinity and/or pH too low • High iron or copper in source water 	<ul style="list-style-type: none"> • Adjust total alkalinity and/or pH • Use a metal deposit inhibitor
Scale	<ul style="list-style-type: none"> • High calcium content in water – total alkalinity and pH too high 	<ul style="list-style-type: none"> • Adjust total alkalinity and pH – if scale requires removal, drain the spa, scrub off the scale, refill the spa and balance the water

Water Terminology

The following chemical terms are used in this Water Quality and Maintenance section. Understanding their meaning will help you to better understand the water maintenance process.

Bromamines: Compounds formed when bromine combines with nitrogen from body oils, urine, perspiration, etc. Unlike chloramines, bromamines have no pungent odor, and are effective sanitizers.

Bromine: A halogen sanitizer (in the same chemical family as chlorine). Bromine is commonly used in stick, tablet, or granular form.

Calcium Hardness: The amount of dissolved calcium in the spa water. This should be approximately 50 -150 ppm. High levels of calcium can cause cloudy water and scaling. Low levels can cause harm to the spa equipment.

Chloramines: Compounds formed when chlorine combines with nitrogen from body oils, urine, perspiration, etc. Chloramines can cause eye irritation as well as having a strong odor. Unlike bromamines, chloramines are weaker, slower sanitizers.

Chlorine: An efficient sanitizing chemical for spas. Aspen Spas recommends the use of sodium dichlor-type granulated chlorine. This type is preferred because it is totally soluble and nearly pH neutral.

Corrosion: The gradual wearing away of metal and plastic spa parts, usually caused by chemical action. Generally, corrosion is caused by low pH or by water with levels of TA, CH, pH or sanitizer which are outside the recommended ranges.

Free Chlorine (or Bromine): The amount of chlorine or bromine remaining after chlorine or bromine demand has been satisfied. The residual is, therefore, the amount of sanitizer which is chemically available to kill bacteria, viruses and algae.

Halogen: Any one of these five elements: fluorine, chlorine, bromine, iodine, and astatine.

MPS: Monopersulfate is the non-chlorine oxidizer. Not a sanitizer.

Nitric Acid: The formulation of nitric acid, a highly corrosive chemical, is a byproduct of the ozone generating process. Nitric acid is produced in very small quantities and is readily dissolved in the water stream with ozone.

Oxidizer: The use of an oxidizing chemical is to prevent the buildup of contaminants, maximize sanitizer efficiency, minimize combined chlorine and improve water clarity. See MPS and Ozone.

Ozone: Ozone is a powerful oxidizing agent which is produced in nature and artificially by man. Ozone forms no byproducts, oxidizes chloramines, and will not alter the water's pH.

pH: The measure of the spa water's acidity and alkalinity. The recommended pH for the spa water is 7.2 to 7.6. Below 7.0 (considered neutral), the spa water is too acidic and can damage the heating system. Above 7.8, the water is too alkaline and can result in cloudy water, and scale formation on the shell and heater.

ppm: The abbreviation of "parts per million", the standard measurement of chemical concentration in water. Identical to mg/l (milligrams per liter).

Reagent: A chemical material in liquid, powder, or tablet form for use in chemical testing.

Sanitizer: Sanitizers are added and maintained at recommended residuals to protect bathers against pathogenic organisms which can cause disease and infection in spa water.

Scale: Rough calcium-bearing deposits that can coat spa surfaces, heaters, plumbing lines, and clog filters. Generally, scaling is caused by mineral content combined with high pH. Additionally, scale forms more readily at higher water temperatures.

Total Alkalinity (TA): The amount of bicarbonates, carbonates, and hydroxides present in spa water. Proper total alkalinity is important for pH control. If the TA is too high, the pH is difficult to adjust. If the TA is too low, the pH will be difficult to hold at the proper level. The desired range of TA in spa water is 80 to 120 ppm.

Hot Tub Troubleshooting

PRIMING THE PUMP – AKA AIR LOCK

Every so often after a spa is drained and refilled you may experience what is called an "air lock". You will hear the pump running but there will be no activity from the jets operated by this pump. This is a sign that the pump is not properly primed.

To correct this situation, please perform the following:

1. Turn off the power to the spa.
2. Remove the cabinet panel in front of the equipment.
3. Turn the power back on to locate the correct pump that needs attention. Typically you hear it running, but see no water moving out of the jets.
4. Turn the power back off.
5. Locate the drain plug on the front of the correct pump and loosen it to allow the air to escape. **DO NOT TAKE COMPLETELY OUT, SIMPLY LOOSEN IT!** You may hear some air releasing, or a small amount of water may escape. Hand tighten the plug.
 - a. *** If you have pliers large enough, you may also loosen the 1.5" or 2" union on the end of the pump to release the air lock.
6. Turn the power back on and activate the pump to be sure that the jets are working at full speed and then tighten the plug to insure that it will not leak. Loosening and tightening the plug may require small pliers. **DO NOT OVER TIGHTEN. PLUGS WILL BREAK OFF.**
7. Reinstall the cabinet panel.

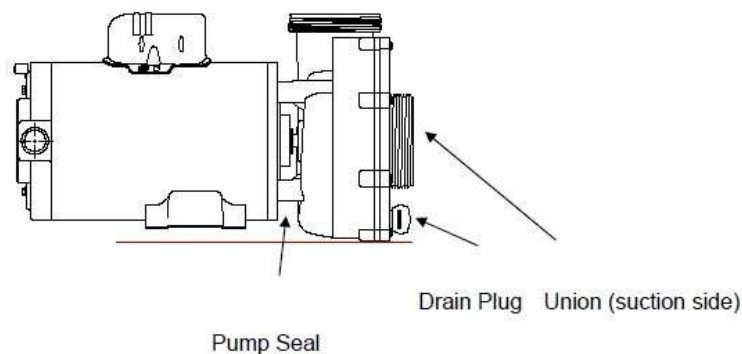

CHANGING THE FILTER

Your Aspen Spa has either a 50 square foot filter or a 100 square foot filter system. Most are changed in the same manner, the only difference is there are 2 – 50 square foot filters in the 100 square foot system. (Alpine, Northstar, Colorado & Pioneer: Just lift up the weir vane to access filter. All other spas follow the forthcoming directions).

***Note: it's best to make sure the spa is not running, filtering or heating when changing filters. When in any of those modes, there is downward suction on the filter and it is harder to pull the filter out.**

1. Slide the face of the filter upwards until it come free of the track. Once out of the track move the filter face towards the inside of the spa so as not to break off the floating weir door.
2. Slide the basket out towards the inside of the spa. It has a track that guides it as well.
3. You can now see the filter tops and each has a small handle. Turn the filter handle counterclockwise until the threads on the bottom of the filter are free.
4. Lift the filter out of the filter housing.
5. If 100 square foot filter, repeat steps 3 & 4 for second filter.
6. Rinse and or clean the filters.

**** Make sure you do not allow any items, i.e. rags, sponges, cleaning supplies, leaves, branches, nature 2 cartridges, metal foam disc, etc. to enter in the spa water and eventually get sucked down into the filter housing. This will eventually either get caught in the plumbing lines or at the pump and will reduce flow to the pump or potentially cause damage to the pump and spa, thus resulting in a chargeable service charge and will NOT be covered under any warranty, parts or labor.**

Reinstalling Clean Filters

1. Slide the filter back into the filter housing
2. Line up the threads and turn the filter clockwise to secure the filter.
3. It's best to tighten the filter, then turn the filter back counterclockwise ½ turn to ensure removal the next time.
4. If 100 square foot system, repeat steps 1-3 for send filter.
5. Now that both filters are installed, slide the basket back into the track for the basket. Make sure it is secure, not floating and pushed all the way in otherwise the filter face will not fit.
6. Final step is to install the filter face. Start with holding the weir door perpendicular to the filter face.
7. Set the filter face with the floating weir door inside the filter housing and right above the track on which the face slides down.
8. Make sure the basket has not floated out slightly.
9. Slide the filter face into place.

***** If you don't make sure the weir door is perpendicular, it's very easy to break off the tabs which hold it in place. Not a warranty issue, so please pay attention and do not force it. If it doesn't slide on easily, something is not in the proper position.**

REPLACING JETS

Aspen Spas built since 2014 use Custom Molded Products – CMP Pro-Loc Jet Systems. Most of the jets in your Aspen Spa are replaceable, whether it's the 2", 3", 4" or 5" jets, they all work the same way. There are some smaller jets that are always on, non-adjustable and you cannot exchange or replace them without getting to the inside of the spa cabinet.

To change or replace a CMP Pro-Loc Jet, simply push in on the outer ring of the jet and twist counterclockwise. It will release. You may find it's easier to perform this task when the spa is not full of water and your hands are not slippery. You can use a rag or something that will aide in gripping the jets. It is best not to use a wrench to help get a jet out. Not only will you damage the face of the jets, you run the risk of the wrench slipping off and scratching the spa.

There are directional, pulsating, and twin roto jets in each jet size, 2", 3", 4" & 5". If you choose to move jets around, exchange a pulsator for a directional, please make sure you are changing like sizes. A 3" jet will not fit in a 4" jet body or vice versa.

REPLACING PILLOWS

Over time pillows will deteriorate due to age, chemical gas off, ozone, heat, etc, so they will need to be changed from time to time. The pillows are very easy to replace.

1. Slide one side of pillow down or up.
2. Now slide the other side down or up.
3. DO NOT PULL OUT! You may damage the pillow or even the fitting installed in the hot tub.
4. To reinstall the pillows, simply line up the pin on the back of the pillow into the receiver installed in the spa.
5. Push the pillow into place. You may need to give it a harder pop to get it to go in.
6. Push in the other side.

DRAINING AND REFILLING INSTRUCTIONS

Your spa should be drained every 3-6 months depending upon variables including usage, bather cleanliness, and attention of water maintenance. When your water seems to be unresponsive to normal chemical procedures, it's probably time to change.

1. Before draining, for best results, add Spa System Flush to spa water.
2. Run pumps on high speed for multiple cycles and on low for 12-24 hours.
3. Turn down the heat to a low setting.
4. Turn power off at outside GFCI disconnect breaker.
5. Drain water down to foot well. To prevent an air lock, we suggest that you do not drain below the intake suction fittings. Most Aspen Spas are equipped with a built in drain.
 - a. Hook your garden hose to the black drain adaptor and lay out hose to desired drainage point.
 - b. Remove black cap from drain located on spa base.
 - c. Screw adaptor into drain to begin draining process.
6. Wipe down surface of spa with an acrylic cleaner.
7. Reinstall drain cap.

***Always refill the spa BEFORE restoring power to it.**

Refer to priming the pump – aka air lock if you hear a pump running but see no water moving out of some of the jets. After the spa has been refilled, follow chemical-start up instruction.

SPA IS TRIPPING GFCI --- WHAT TO DO IN WINTER MONTHS?
***** DEFINITELY NEED TO TAKE PRECAUTIONS, BUT DON'T PANIC!!!**

It's cold out, but it will take time to for the temperature to drop down and damage the spa. Many times, the GFCI is tripping due to a heater failure.

1. Immediately call your Aspen Spa dealer and report the issue.
2. Do not drain the spa! If you do drain it, there will still be water in the spa lines, pump and pack and that little bit of water will freeze much more quickly.
3. Try to reset the spa GFCI disconnect breaker and before the heater tries to start, run the heat down.
4. If that works, the spa will continue to filter and run, keeping the water moving.

If that does not work and the spa(GFCI) will not reset

1. Do not drain the spa! If you do drain it, there will still be water in the spa lines, pump and pack and that little bit of water will freeze much more quickly.
2. Remove one panel on the hot tubs, ideally the front panel with the pump(s) and spa pack.
3. Install a heat lamp or light bulb inside the spa cabinet. Take precautions so it is not touching anything flammable. The heat generated from the light bulb will emit heat and help preserve the spa plumbing lines.
4. Reinstall the cabinet panel, leaving the bottom screws out in one corner so it does not pinch the extension cord.

There is no guarantee the spa will not freeze, but it has the potential to help protect the spa and plumbing by buying time until a service technician can assess the problem.

POWER OUTAGE DURING THE WINTER MONTHS
***** DEFINITELY NEED TO TAKE PRECAUTIONS, BUT DON'T PANIC!!!**

It is cold out, but it will take time to for the temperature to drop down and damage the spa.

1. Do not drain the spa! If you do drain it, there will still be water in the spa lines, pump and pack and that little bit of water will freeze much more quickly.
2. When the power does come back on, make sure the spa is operating normally.
3. If power outage or power surge damaged the spa equipment and it will not turn on, immediately call your Aspen Spa dealer and report the issue.
4. Remove one panel on the hot tubs, ideally the front panel with the pump(s) and spa pack.
5. Install a heat lamp or light bulb inside the spa cabinet. Take precautions so it is not touching anything flammable and safe. The heat generated from the light bulb will emit heat and help keep the spa plumbing lines from freezing.
6. Reinstall the cabinet panel, leaving the bottom screws out in one corner so it does not pinch the extension cord.

There is no guarantee the spa will not freeze, but it has the potential to help protect the spa and plumbing by buying time until a service technician can assess the problem.

Operating Instructions

GECKO SPA PACKS - OPERATING INSTRUCTIONS



Quick Reference Card

Please consult your spa user manual for complete info on the features of your spa system.



in.k300™ Compact full-function keypad

The Quick Reference Card provides an overview of your spa's main functions and the operations accessible from your digital keypad. This QRC depicts a generic overlay, custom versions may vary.

Description

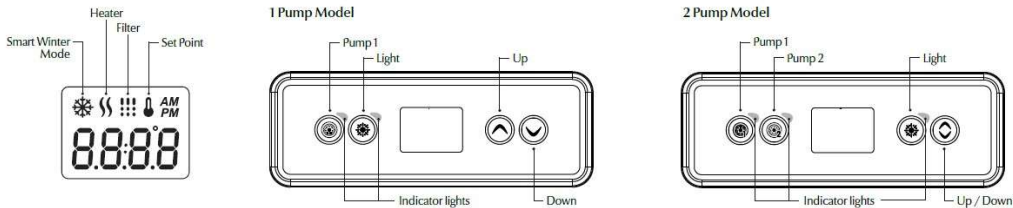

Spa Functions



Off Mode

Pressing **Pump 1** for 5 seconds will enable the Off mode. This mode allows you to stop all outputs including automatic functions such as filter cycle, heat request and smart winter mode for 30 minutes to perform quick spa maintenance. When Off mode is active, the display will toggle between the "OFF" message, the clock and the water temperature. The spa light will flash for a few seconds before the end of the 30 minutes to warn you that the system is about to resume its normal operation. Press **Pump 1** or **Pump 2** (if available) to restart the system before the expiration of the 30 minute delay. When the system resumes its normal operation, the display shows "On" for 3 seconds.

Pump 1

Press **Pump 1** key to turn Pump 1 on at low speed. Press a second time to turn pump to high speed (with a dual-speed pump*). A third time turns pump off. A built-in timer automatically turns pump off after 20 minutes, unless pump has been manually deactivated first. The "Pump 1" indicator lights up when Pump 1 is on. With a dual-speed pump, the indicator will flash when pump 1 is on at low speed.

Pump 2 key

Not available on all models. Press **Pump 2** key to turn Pump 2 on at low speed. Press a second time to turn pump to high speed (with a dual-speed pump*). A third time turns pump off. A built-in timer automatically turns pump off after 20 minutes, unless pump has been manually deactivated first. The "Pump 2" indicator lights up when Pump 2 is on. With a dual-speed pump, the indicator will flash when pump 2 is on at low speed.

Light key

Press **Light** key to turn light on. A second press turns light off. A built-in timer automatically turns light off after 2 hours, unless it has been manually deactivated first. The "Light" indicator lights up when light is on.

Up/Down keys

Use **Up** or **Down** key to set desired water temperature. The temperature setting will be displayed for 2 seconds to confirm your new selection. 2 pump spas have a combined Up/Down key. Hold the button to increase the parameter and release the button to stop. Hold the button again to decrease the parameter. The "Set Point" icon indicates that the display shows the desired temperature, NOT the current water temperature!

* If single speed pump: press Pump key to turn pump on. Press Pump key again to turn pump off.

Programming Steps



Program menu

The program menu is accessible by holding down the **Light** key for 5 seconds. In the program menu the following parameters can be set: clock, the filter or purge cycles, economy mode and temperature units. While you are in the program menu, use the **Up** or **Down** key to adjust the parameters and use the **Light** key to jump to the next parameter. The changes will be saved after the confirmation of

the last parameter only. If there is no action taken for 10 seconds, the system will exit the program menu without saving any changes.



Setting the clock

Enter the program menu by holding down the **Light** key for 5 seconds. The display will show the current clock setting with the hour flashing.

Depending on factory settings your system may be set to 24-hour time or 12-hour time. **Setting the hour:** Use the **Up** or **Down** keys to adjust the hours. Press the **Light** key to jump to the next parameter, the minutes.

Setting the minutes: Use the **Up** or **Down** keys to adjust the minutes. Press the **Light** key to jump to the next parameter, the filter or purge start time (FS).

Programming the filter/purge cycles

Depending on system configuration your spa will perform either a filter or a purge cycle. The filter cycle menu consists of the following parameters: the start time (FS), the duration (Fd) and the frequency (FF). The purge cycle menu consists of the following parameters: the start time (FS) and the frequency (FF).

A filter cycle consists of starting all the pumps and blower in high speed for 1 minute (purge step) then, the pump associated with the filter will run in low speed for the remaining duration of the filter cycle (clean step).

A purge cycle is used when the spa is equipped with a 24-hour circulation pump which provides a continuous clean step. It consists of starting all the pumps and blower in high speed for 1 minute.



Setting filter or purge cycle start time

The display will show FSxx, "xx" representing the starting hour of the cycle. Use the Up or Down key to adjust the hours. Use the Light key to jump to the next parameter, filter duration (Fd).



Setting filter cycle duration

(not available on purge systems)
The display will show Fdxx, "xx" representing the duration in hours of the filter cycle. Use the Up or Down key to adjust the duration. Use the Light key to jump to the next parameter, filter or purge frequency (FF).

0 = no filtration
24 = continuous filtration

It is not recommended to set this to "0".



Setting filter or purge cycle frequency

The display will show FFxx, "xx" representing the number of cycles per day. Use the Up or Down key to adjust the frequency. Use the Light key to jump to the next parameter, economy mode (EP).

The "Filter cycle" indicator lights up when filter is on and flashes when suspended.



Setting economy mode

This mode allows you to lower the temperature set point of the spa by 20 °F (11 °C) during a certain period of the day.

The display will show EPx, "x" representing the state of the programmed economy (0 = disabled, 1 = enabled). Use the arrow keys to enable or disable economy mode. Use the Light key to jump to the next parameter, economy start time (ES).



Setting economy start time

The display will show ESxx, "xx" representing the hour at which the economy mode will become active. Use the Up or Down key to adjust the hour. Use the Light key to jump to the next parameter, economy duration (Ed).

When the Economy mode is ON, the display will toggle between the "eco" message, the time, and the water temperature.



Setting economy duration

The display will show Edxx, "xx" representing the duration in hour of the economy mode. Use the Up or Down key to adjust the hour. Use the Light key to jump to the next parameter, temperature unit.

24 = continuous economy

Note that the parameters for the economy mode settings are associated to specific low level configuration of the system that are not present in all software revisions.



Setting temperature unit

Water temperature can be displayed in either Fahrenheit (°F) or Celsius (°C). The display will show F or C.

Use the Up or Down key to change the setting. Use the Light key to save all the parameters.



Smart Winter Mode

Our Smart Winter Mode protects your system from the cold by turning pumps on several times a day to prevent water from freezing in pipes.

The "SWM" indicator lights up when freezing is detected and flashes when the purge is active.

Cooldown

After heating the spa water to the desired Set Point, the heater is turned off, but its associated pump (Pump 1 low-speed or CP) remains on for a predetermined period of time to ensure adequate cooling of the heating element, prolonging its useful life.







Water temperature regulation

Every 15 to 90 minutes the pump will run to ensure accurate water temperature readings as well as avoid heater activation in dry conditions. After verifying pump activation and taking a water temperature reading if required, the system automatically turns the heater on to reach and maintain water temperature at Set Point.

 Indicator flashes when taking water temperature reading.

Troubleshooting section

Should an error occur, the display will show one of the following error messages toggled with the clock and the water temperature.

in.xe error codes	Description
	Hr An internal hardware error has been detected in the in.xe. Contact dealer or service supplier.
	HL The system has shut the heater down because the temperature at the heater has reached 119°F (48°C). Do not enter the water! Remove the spa cover and allow the water to cool down, then shut power off and power your spa up again to reset the system.
	AOH Temperature inside the spa skirt is too high, causing the internal temperature in the in.xe to increase above normal limits. Open skirt and wait until error clears.
	FLO The system does not detect any water flow while the primary pump is running. Check and open water valves. Check for water level. Clean filter. If the problem persists, call your dealer or service supplier.
	Prr A problem is detected with the temperature probe. Call your dealer or service supplier.
	OH The water temperature in the spa has reached 108°F (42°C). Do not enter the water! Remove the spa cover and allow the water to cool down to a lower temperature. Call your dealer or service supplier if problem persists.



Quick Reference Card

Please consult your spa user manual for complete info on the features of your spa system.



in.k500™ intuitive color keypad

The in.k500 is built with all the great features you've come to love in the in.k800, but in a smaller package. It is discreet, compact, and unobtrusively beautiful. Save space without losing out on function.

Description

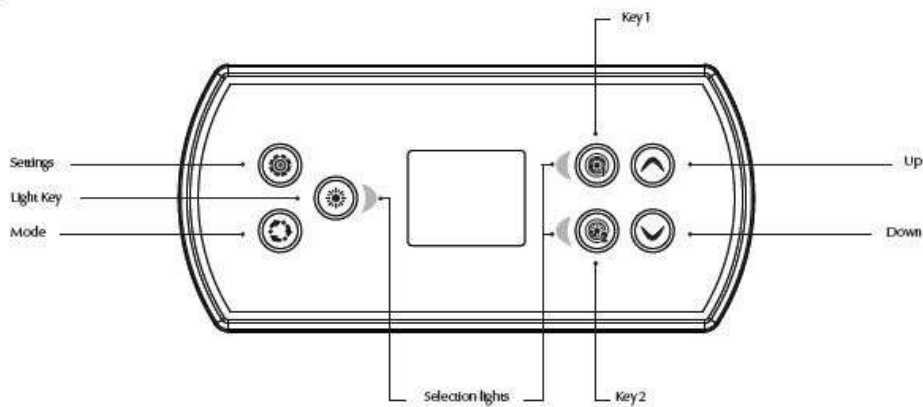

**Functions for keys 1 and 2 will depend on your system's low level configuration.*

Main functions



Power

Press any button to turn the keypad on.
After 30 minutes without activity it will shut off.

Main screen

The main screen gives you access to your accessories and water temperature. At the bottom of the screen you will see any error or maintenance messages that are present.



Start or stop accessories

To start or stop an accessory, press the associated button. Icons will become animated when their accessory is turned on, and inanimate when turned off. Icons on the screen will reflect the speed or state of the devices running on your spa.

When an accessory has more than two states, press the button until it reaches the desired state.



Water temperature

The temperature shown at the top of the screen gives the actual water temperature.

Use the Up and Down buttons to set the desired temperature. The set point will appear in blue at the bottom. After 3 seconds without any change to the set temperature value, the keypad will resume the normal display of messages.

Settings



Settings

From the home page you can access the Settings, where you will find:

Water care
 Audio (if installed)
 Day & time
 Keypad
 Config*
 Restore*
 About

Use the arrow keys to move up and down in the list. To select an option, press the lit button beside it (Light button).

At any point you can press the Settings button to return to the home screen.

*reserved for qualified electricians installers



Water care

The Water Care section will help you set up your ideal filtration and heating settings. Choose a mode depending on your need.

Use the Light key to choose your setting. A checkmark will appear on the selected icon to confirm.

In Energy Savings mode, the set point will be reduced by 20°F, which means that the heating system will not be engaged unless the temperature falls to 20°F below the spa's set temperature.

*Default pack value

Water care modes

-  **Away:**
 In this mode the spa will always be in economy; the set point will be reduced by 20°F and filtration will be reduced.
-  **Beginner:**
 The spa will never be in economy mode, and will run a normal 8 hours of filtration a day.
-  **Energy Savings:**
 The spa will be in economy mode during the peak hours of the day and resume normal mode on the weekend.
-  **Super Energy:**
 The spa will always in economy mode during peak hours, every day of the week.
-  **Weekender:**
 The spa will be in economy mode from Monday to Friday, and will run normally on the weekend.



Modifying schedules

Use the arrow keys to scroll through the Water Care selections. To see and/or modify a Water Care category, use the lit button to the right (key I) to open the selected Water Care menu.

Use the arrow keys to choose a schedule to modify (choice of economy and filtration schedules). Use the Light key to move between parameters.



You have several possibilities for the schedule (Mon-Fri, weekend, every day, or single days). The schedules will be repeated every week. The time and duration are set in 30 minute increments. Once you have set the schedule, use key I to go back. Ensure that you have selected the desired Water Care option in the main Water Care menu.

If your spa uses a circulation pump configured to run 24 hours, the screen will show you the purge setting instead of filtration. The purges are pre-programmed for a fixed number of minutes, therefore the duration will be set to N/A on the screen, and only the start time can be modified.



Audio (with in.stream only)

The in.k500 can be used with either the in.tune or in.stream audio system. The Audio section in the Settings menu gives you the option to disconnect or unpair your Bluetooth enabled device when using the in.stream.

The Mode key (audio access) is only present/functional when the spa is equipped with a Gecko audio component (in.stream or in.tune). The keypad will be set appropriately at the factory.

The Audio option will only appear in the Settings menu for keypads that are set up for an in.stream connection.



Day and time

Here you can adjust the time format, and change the day and time. Use the arrows to choose the setting that you want to adjust, and select it by pressing the Light key. Use the arrow buttons to change the parameters, and the Light key to move between parameters.

Key 1 will take you back to the main Settings menu.



Keypad settings

In this section you can change the temperature unit and language. Use the arrow keys, and move to the setting that you would like to change. Use the Light key to choose, and then the arrow keys to modify.



About

This section shows information about the in.k500 software number, and the revision numbers of the different components of your system.

Audio operation



in.tune operation

Press the Mode key to access your in.tune.

Play/Pause audio

Press the Play/Pause key to start or pause the audio.

Adjusting the volume

Press the Up or the Down key to increase or decrease the volume.

Changing tracks

Use the Last Track and Next Track keys to change tracks for the CD or AUX input. When in Radio mode, the Last Track and Next Track keys will move through preset radio stations on the selected band. To change bands or preset stations, see your in.tune manual.



in.stream operation

Press the Mode key to access your in.stream.

Play/Pause audio

Press the Play/Pause button to start or pause the audio.

Adjusting the volume

Press the Up or the Down key to increase or decrease the volume.

Changing tracks

Use the Last Track and Next Track keys to change tracks.

Disconnect or Unpair Bluetooth

These options can be found under the Audio section in the Settings menu.



Quick Reference Card

Please consult your spa user manual for complete info on the features of your spa system.



in.k800 intuitive color keypad

With its bright, full color display, the in.k800 provides an intuitive user experience, while its screen's high resolution brings hot tub user interfaces to a new level. Loaded with a large amount of memory and a powerful on-board processor we have created the seamless graphic interface that spa users have been waiting for.

Description

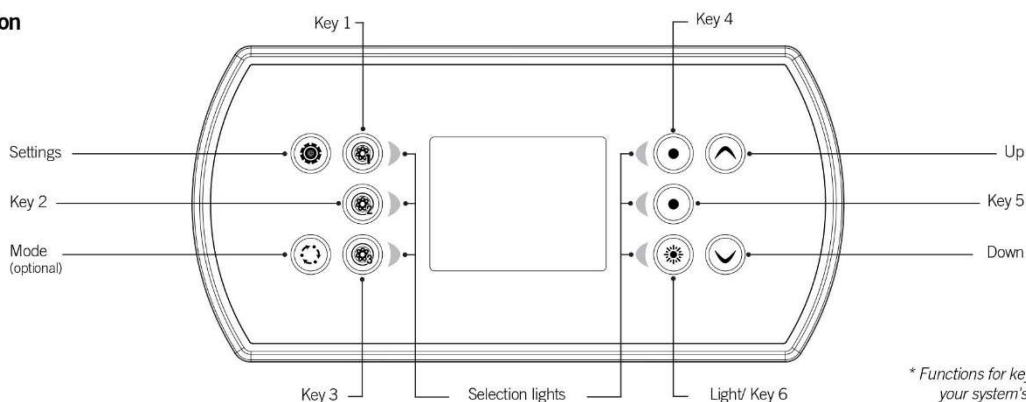

* Functions for keys 1 to 5 will depend on your system's low level configuration.

Main functions



Settings key

One press gives you access to a menu to manage the settings of your spa. Refer to the settings section for details about the settings menu.

Mode key

Successive presses on the Mode key will give access to control different optional accessories of your spa such as Audio and others. Note that if an accessory is not present in your spa configuration, its menu will not appear. Refer to the following section to get details about the possible accessories and their detailed functionalities. The screen will revert back to the spa mode if no key is pressed for 60 seconds. Depending on pack configuration, Mode key may also be used to change the display orientation when an accessory is not present.

Power

Press any button to turn the keypad on. After 30 minutes without activity it will shut off.

Main screen

The main screen gives you access to your accessories and water temperature. At the bottom of the screen you will see any error or maintenance messages that are present.

Notifications

A notification area at the top right-hand side of the screen shows the state of certain accessories installed in the spa.

- in.mix:**
 - Indicates that an in.mix system is detected.
- in.clear:**
 - The icon is green when the in.clear is generating bromine.
 - The icon is grey when the in.clear isn't generating bromine.
 - A red cross indicates that the in.clear is turned off.
- in.touch:**
 - Indicates that the in.touch module is detected and connected to a Wi-Fi network.
 - A red cross indicates that the in.touch module is detected but isn't connected to a Wi-Fi network.
- in.stream 2:**
 - The icon is green when the in.stream 2 is ON.
 - The icon is grey when the in.stream 2 is OFF.
- Keypad security:**
 - Indicates that the keypad is locked.
 - For more information about keypad security, refer to the keypad settings section.

For more information about the in.mix, in.clear, in.touch or in.stream 2, refer to the Techbook.



Start or stop accessories

To start or stop an accessory, press the associated button. Icons will become animated when their accessory is turned on, and inanimate when turned off. Icons on the screen will reflect the speed or state of the devices running on your spa. When an accessory has more than two states, press the button until it reaches the desired state.

Water temperature

The temperature at the bottom of the screen shows the current water temperature. Use the Up and Down buttons to set the desired temperature.

The set point will appear in blue. After 3 seconds without any change to the set temperature value, the current water temperature will reappear.

Settings



Settings

From the home page you can access the Settings, where you will find:

- Water care
- Heat Pump (if installed)
- Audio
- in.clear-200 (linked version)
- Maintenance
- Date and time
- Keypad Settings
- Wi-Fi
(only available on in.touch with software 11.00 or higher)
- Miscellaneous
- Electrical configuration
- About

Use the arrow keys to move up and down in the list. To select an option, press the lit button next to it (key 2).

At any point you can press the Settings button to return to the home screen or key 1 to go back.



Modifying schedules

To modify a Water Care mode, use the lit key to the right (key 5) to open the selected Water Care menu.

You can add schedules by scrolling down to Add, and selecting with key 2. To delete a schedule, press key 4.

You can modify the programmed schedules by selecting one and adjusting the schedule using the arrow keys. Use key 2 to move between parameters.

You have several possibilities for the schedule (Mon-Fri, weekend, every day, or single days). The schedules will be repeated every week. The time and duration are set in 30 minute increments. Once you have set the schedule, use key 1 to go back. Ensure that you have selected the desired Water Care mode in the main Water Care menu.



Water care

The Water Care section will help you set up your ideal filtration and heating settings. Choose from Away from Home, Standard, Energy Savings, Super Energy Savings, and Weekender, depending on your need. Use key 2 to choose your setting. A green checkmark will appear on the selected icon to confirm.

In Energy Savings mode, the set point will be reduced by 20°F*, which means that the heating system will not be engaged unless the temperature falls to 20°F below the spa's set temperature.

The filtration schedule shown on the screen will apply to the main filtration pump, most likely pump 1. If your spa uses a circulation pump configured to run 24 hours, the screen will show you the purge setting instead of filtration. The purges are pre-programmed for a fixed number of minutes, therefore the duration will be set to N/A on the screen, and only the start time can be modified.

* Default pack value



Heat pump

This menu allows you to change the regulation mode of your heat pump. You can choose from Eco Heat, Smart Heat, Eco Auto, Smart Auto, Cool and Electric.

A green checkmark indicates the currently selected regulation mode. To change the setting, simply navigate the menu using the arrow key and press key 2 to choose the desired regulation mode.

Heat pump modes



Eco Heat

In this mode, the heat pump is used as the unique source of heating. The heating element is kept off and the heat pump is not used to cool the water should its temperature rise above the current set point.

Water care modes



Away from home:

In this mode the spa will always be in economy; the set point will be reduced by 20° F.



Standard:

The spa will never be in economy mode and will be filtering according to the pack's low level configuration.



Energy Savings:

The spa will be in economy mode during the peak hours of the day and resume normal mode during the evening hours and on the weekend.



Super Energy:

The spa will always be in economy mode during peak hours, every day of the week.



Weekender:

The spa will be in economy mode from Monday to Friday, and will run normally on the weekend.



Default Settings:

When you select Default Settings you will be asked to confirm your choice. Doing so will restore all Water care schedules to default settings.



Smart Heat

This mode uses the heat pump as the main heating source. The heating element is turned on only if there is a large temperature difference between the water and the set point. The heat pump is not used to cool the water in this mode.



Eco Auto

This mode borrows functionality from both Eco Heat and Cool modes and has the ability to select the proper Heat or Cool mode automatically according to the water temperature. The heating element is never activated in this mode.



Smart Auto

This mode borrows functionality from both Smart Heat and Cool modes and has the ability to select the proper Heat or Cool mode automatically according to the water temperature. The heating element is activated only if there is a large temperature difference between the water and the set point.



Cool

This mode uses the heat pump in cooling mode only. The heat pump is not used as a heating source and the heating element is never activated.



Electric

This mode keeps the heat pump off and uses only the heating element to regulate water temperature.

Settings



Maintenance

From the Settings page you can access the Maintenance menu, which gives you access to the following options:

- Maintenance reminders
- Standby

Use the Up and Down keys to make a selection, and key 2 to confirm.



Maintenance reminders

The in.k800 keypad will remind you of maintenance required on your spa, like rinsing or cleaning the filter. Each task has its own duration, based on normal use.

The Maintenance reminders menu allows you to verify the time left before maintenance is required, as well as to reset the time once a task is completed.

Use the Up and Down keys to move through the list.

To reset a task select it by pressing key 2, then confirm when prompted. Once you have confirmed the task will be reset.



When you select Reset reminders you will be asked to confirm your choice. Doing so will reset all maintenance reminders to default values.



Standby

The Standby mode allows you to service your spa. Pumps will stop for 30 minutes, and automatically restart after this time.

Once Standby mode has been activated a screen will appear to show that pumps are stopped. The spa page will return at the end of maintenance.

Press on the Confirm key to leave Standby mode and restart the spa.



Date and time

Here you can adjust the time format, change the year, date, and time. Use the arrows to choose the setting that you want to adjust, and select it by pressing key 2.

Use the arrow keys to change the parameters, and key 2 to move between parameters. Key 1 will take you back to the main Settings menu.



Keypad settings

In this section, you can change the temperature unit, language, display orientation, rim light color* and keypad security. Note the spa pack must be configured accordingly to be able to change the rim light color.

Use the arrow keys to choose the setting that you want to adjust. Select it by pressing key 2 then use the arrow keys again to change the setting.

When you change the display orientation, the contextual options and arrow keys adjust to the chosen orientation. The Mode and Menu keys remain unchanged, as well as the accessory keys in the main Spa menu.

You can lock the keypad by selecting one of 3 security levels: Unlock, Partial or Full. The Partial level locks the set point adjustment and many options in the settings menu. The Full level locks all keypad functions. To unlock the keypad (either Partial or Full), press and hold the top right key for 5 seconds.

* Since v23.00, if an in.mix is installed, you can synchronize the color of rim light with an in.mix zone.

Settings



Miscellaneous

In this section, you can change the Warm weather* and Info messages options.

You can bypass the pack filtration over-temperature feature. When Warm weather is "Off", the filtration over-temperature is disabled. This feature allows the spa to continue filtering even through the water temperature is high.

You can configure the main window message center. When set to Display, all information messages are displayed without exception and when set to Hide, some detailed messages are not displayed when they occur to keep the message center simple.

* Depending of pack configuration



About

This section shows information about the in.k800 software number, and the revision numbers of the different components of your system.

Wi-Fi (in.touch only)



For the Wi-Fi menu to appear in the Settings menu your in.touch module must be equipped with software version 11.00 or higher. This menu allows you to connect your in.touch module to a Wi-Fi network or to change its network.

For more details about other in.touch connection methods please see the in.touch techbook.

To connect your in.touch module to a wireless network, use the Up/Down keys to go to the Wi-Fi option in the Settings menu and key 2 to select it.



After a few seconds the available networks will appear on the screen, as well as their signal strength.

Use the Up/Down keys to move through the list. Select your network by pressing on key 2.

If the Wi-Fi network is password protected enter it when prompted.

- Use the arrow keys to choose your letters
- Use key 6 to move the cursor forward
- Use key 4 to change the type of character (uppercase, lowercase, number, symbol)
- Use key 3 to backspace
- Use key 2 to confirm



If no password is required the in.touch will connect automatically.

Once the in.touch module is connected to a Wi-Fi network a green check mark will appear in the Wi-Fi menu, and the network name will appear in the Settings menu.

Audio



Audio

The in.k800 can be used with the in.tune, in.stream or in.stream 2 audio system.

The Audio section in the Settings menu gives you the option to disconnect or unpair your Bluetooth enabled device when using the in.stream.

The in.stream 2 Settings menu gives you a Bluetooth disconnect feature and an audio control on fader, balance and subwoofer.

For more information on audio functions, see the in.tune, in.stream or in.stream 2 operation section.



in.stream 2 functions

This menu is available only if the in.stream 2 was detected at power up.

Press the Mode key to access your in.stream 2.

If you are using a device with Bluetooth technology, it must be connected for functions to work.

Please note that the Play/Pause functions apply only to Bluetooth and USB source. Change Track or station functions works with all sources except AUX.

Turning power on/off

Press the Power key to turn the in.stream 2 on or off.

Selecting the source

Press the Source key to toggle between available sources.



in.tune functions

This menu is only available if the in.tune option was selected during production.

Press the Mode key to access your in.tune.

Turning power on/off

Press the Power key to turn the in.tune on or off.

Selecting the source

Press the Source key to choose between CD, Auxiliary input, and Radio.

If no source is selected, the in.tune will use the last selected source.

Play/Pause audio

Press the Play/Pause key to start or pause the audio.

Adjusting the volume

Press the Volume Up or the Volume Down key to increase or decrease the volume.

Changing tracks

Use the Last Track and Next Track keys to change tracks for the CD or AUX input. When in Radio mode, the Last Track and Next Track keys will move through preset radio stations on the selected band. To change bands or preset stations, see your in.tune manual.



in.stream functions

This menu is only available if the in.stream option was selected during production.

Press the Mode key to access your in.stream.

If you are using a device with Bluetooth technology, it must be connected for functions to work.

Please note that the Play/Pause and Change Track functions apply to devices using Bluetooth technology only, and will not work when AUX is selected as the source.

Turning power on/off

Press the Power key to turn the in.tune on or off.

Selecting the source

Press the Bluetooth key to select a device using Bluetooth wireless technology.

Press the Source key to use a device connected to the auxiliary cable.

If no source is selected, the in.stream system will use the last selected source.

Play/Pause audio

Press the Play/Pause button to start or pause the audio.

Adjusting the volume

Press the Volume Up or the Volume Down key to increase or decrease the volume.

Changing tracks

Use the Last Track and Next Track keys to change tracks.

Disconnect or Unpair Bluetooth

These options can be found under the Audio section in the Settings menu.

Play/Pause audio

Press the Play/Pause button to start or pause the audio.

Adjusting the volume

Press the Volume Up or the Volume Down key to increase or decrease the volume.

Changing tracks

Use the Last Track and Next Track keys to change tracks. Note that on FM these functions can be use to change stations.

Disconnect

This option can be found under the Audio section in the Settings menu.

Fader, Balance and Subwoofer

Fader, Balance and Subwoofer settings can be edited under the Audio section in the Settings menu if your in.stream 2 supports it.

in.clear



in.clear-200 (linked version)

The in.k800 keypad can be used with the in.clear sanitization system. The in.clear section allows you to configure your maintenance settings and Boost level.

For more information on maintenance and Boost settings, see the in.clear user manual.

Use the Up and Down keys to make your selection, then key 2 to confirm.

Use the Up and Down keys to change the maintenance or Boost value, and key 2 to confirm.

** If the maintenance value is modified by more than 2, a warning message will appear with an option to cancel or confirm the change.*



in.clear functions

This menu is only available if an in.clear linked is detected.

Press on the Mode key to access your in.clear module.

This menu allows you to activate or deactivate your in.clear, to start or stop a Boost, and to enter diagnostic mode.

Turning the in.clear on/off

Press the power key to turn the in.clear on or off.

Control the Boost level

Press on the Boost activation/deactivation key to start a Boost, and again to cancel.

To adjust the Boost level use the arrow keys.*

A message indicating that Boost mode is active is displayed at the bottom of the main screen for the duration of the boost.

** See the in.clear user manual for more details about Boost levels.*



Diagnostic Mode

Press on the Diagnostic key to start a BromiCharge concentration level test. To exit diagnostic mode press on the Diagnostic key again. The system will automatically exit after 15 minutes.

In diagnostic mode, the BromiCharge gauge indicates the approximate level of BromiCharge in the spa water. Do not add BromiCharge if the indicator is in the green zone.

When BromiCharge is added the indicator will move slowly to the right. When water is added to the spa the indicator will move to the left. To obtain a good level of BromiCharge, start the pumps and add the specified amount of BromiCharge** and allow 5 minutes for the indicator to adjust before adding more.

For optimal performance, aim for the middle of the green zone.

*** For more information on adjusting your BromiCharge level see the in.clear user manual.*

in.mix



in.mix functions

This menu is only present if an in.mix system is detected.

Press on the Mode key to access your in.mix.

By default, the in.mix selects Zone 1 when you access the menu. After the first use the menu will automatically return to the last zone selected.

Zone selection:

The zone selection keys allow you to select a zone to modify its color.

- Press once to select the zone.
- Press a second time to deactivate the zone.

Changing colors:

Once a zone is selected use the arrow keys to change the colors by moving up and down in the color wheel.

Synchronizing zones:

The synchronization/desynchronization key allows you to match the color of the selected zone to the other zones.



Quick Reference Card

Please consult your spa user manual for complete info on the features of your spa system.

in.k1000 touch screen keypad

No buttons, keys and overlays! Mode and function selection wheels, all-on or all-off one touch activation key of last used settings, interactive display icons and on-screen messages are all elements of the in.k1000 user interface designed to let spa users interact intuitively with their spa and its value-added accessories.



notification icons

Notification icons at the top right-hand side of the screen show the status of connected value-added accessories.



spas functions

Quick and easy step-by-step instructions to control the main functions and to configure system settings of your spa from its in.k1000 main spa keypad.



turn keypad on

3 minutes after the last pump is turned off, the screen will shut off if there is no touch activity.

Touch the screen to turn on the keypad. Then follow the instructions on the screen to access the main screen.

all-on, all-off target key

in.k1000 features an all-on or all-off one touch activation key. When pressed, it tops or starts all working components and accessories at once.

From the home page, you can access the following modes:

- sanitization (with In.clear connected)
- audio (with In.stream 2 connected)
- color (with In.mix installed)
- spa
- settings

To select a mode, slide the left wheel up or down until the desired icon menu is highlighted in the middle.



spa mode



spa mode

To select the spa mode, slide the left wheel up or down until the spa icon is highlighted in the middle.

The home page will display its equipment start or stop keys, up and down buttons, water temperature, messages and quick access to display options.

- display orientation
- display contrast

To select an option, slide the right wheel up or down until the desired icon menu is highlighted in the middle.

start or stop accessories

To start or stop an accessory (pump, blower, light), touch the associated icon. Icons will become animated when their accessory is turned on, and animation will stop when turned off.

Icons on the screen will reflect the speed or state of the devices running on your spa. When an accessory has more than one speed press the button until it reaches the desired speed.

water temperature

The temperature at the bottom of the screen shows the current water temperature. Use the Up and Down icon to set the desired temperature. The set point will appear in blue. After 3 seconds without any changes to the set temperature value, the current water temperature will reappear.

When the set value is lower than the current temperature Cooling to xxx will appear below. When the set value is higher than the current temperature, Heating to xxx will be indicated under the value. Normally there is a short delay before the heating starts, during which Heating Suspended is indicated under the value.



display orientation

To modify the display orientation settings, slide the right wheel until the display orientation icon is highlighted in the middle.

Simply touch the line of the orientation you want to select.

display contrast

To modify the display contrast settings, slide the right wheel until the display contrast icon is highlighted in the middle.

Simply touch the line of the contrast you want to select.

sleep

Press key to go directly into the sleep mode. In sleep mode, water splashing on the keypad can't inadvertently start/stop a pump.

settings

You can use the Settings mode to manage settings of your spa system.



To select the settings mode, slide the left wheel up or down until the settings icon menu is highlighted in the middle.

In the Settings page you can access the following:

- water care
- maintenance
- date & time
- keypad
- electrical configuration
- wifi
- miscellaneous
- about

To select an item, slide the right wheel until the desired icon is highlighted in the middle or press on the menu name.



water care

The Water care page will help you set up your ideal filtration and heating settings. The Water care page will help you set up your ideal filtration and heating settings. Choose, set or modify one of the 5 suggested modes depending on your needs at any given time.



Away from home

In this mode the spa will always be in economy; the set point will be reduced by 20° F.



Beginner

The spa will never be in economy mode and will be filtering according to the pack's low level configuration.



Energy Savings

The spa will be in economy mode during the peak hours of the day and resume normal mode on the weekend.



Super Energy

The spa will always be in economy mode during peak hours, every day of the week.



Weekender

The spa will be in economy mode from Monday to Friday, and will run normally on the weekend.

modifying water care schedules



water care

To modify a Water care category, touch the pen icon at the right end of the desired water care to open the selected Water Care menu.



economy

Touch the Economy tab to change the economy schedule. You can add economy schedules by touching the orange line labeled "Add Economy". To delete a schedule, touch the garbage can icon at the right end of the desired line.



filter cycles

Touch the Filter cycle tab to change the filter cycle schedules. You can add filtration schedules by touching the orange line labeled "Add filter cycle". To delete a schedule, touch the garbage can icon at the right end of the desired line.

In Economy mode, the set point will be reduced by 20°F, which means that the heating system will not be engaged unless the temperature falls to 20°F below the spa's set temperature.

The filtration schedule show on the screen will be applied to the main filtration pump, most likely pump 1. If your spa uses a circulation pump configured to run 24 hours, the screen will show you the purge setting instead of filtration. The purges are pre-programmed for a fix number of minutes, therefore the duration will be set to N/A on the screen, and only the start time can be modified.



You can modify the programmed schedules by selecting one and adjusting the schedule. You have several possibilities for the schedule (Mon-Fri, weekend, every day, or single days). The schedules will be repeated every week. The time and duration are set in 30 minute increments.



Once you have set the schedule, press "Confirm". If you don't want to keep any changes, press "Cancel" or use the calendar icon to go back.



purges

Touch the Purge tab to change the purge settings. You can add purges by touching the orange line labeled "Add purge time". To delete a schedule, touch the garbage can icon at the right end of the desired line.



You can modify the programmed purges by selecting one and adjusting the schedule. You have several possibilities for the schedule (Mon-Fri, weekend, every day, or single days). The time and duration are set in 30 minute increments. Once you have set the purges, press "Confirm". If you don't want to keep changes, press "Cancel" or the calendar icon.



maintenance



maintenance

To modify maintenance settings, slide the right wheel until the maintenance icon is highlighted in the middle.

From the Maintenance page you can access the following:

- Reminders
- Standby

Simply touch the line of the item you want to change.



reminders

The In1000 keypad will provide reminders about maintenance required on your spa, like rinsing or cleaning the filter. Every task has its own duration, based on normal use.

The reminders menu allows you to check the time left before maintenance is required, as well as to reset the time once a task has been completed.

To reset a task, select it by pressing the curved arrow, then confirm when prompted. Once you have confirmed, the task will be reset.

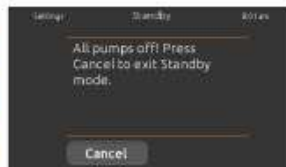

standby

The Standby mode allows you to service your spa. Pumps will stop for 30 minutes and will automatically restart after.

The normal page will return at the end, once the pumps will be restarted.

date and time



date and time

To modify date and time settings, slide the right wheel until the date and time icon is highlighted in the middle.

Simply touch the line of the item you want to change.



set date

Here you can adjust the year, month and date. Simply swipe up and down the column you want to change, and select the desired value. When done, touch the calendar icon at the right of the screen.



set time

Here you can change the hour, minute and time format. Simply swipe up and down the column you want to change, and select the desired value. When done, touch the calendar icon at the right of the screen.

keypad settings



keypad settings

To modify keypad settings, slide the right wheel until the keypad icon is highlighted in the middle.

Simply touch the line of the item you want to change.



temperature units

Use this page to set or change the temperature in F° or C° units.

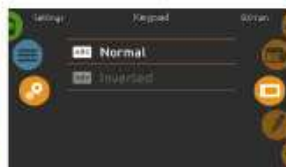

display orientation

Use this page to set or change the normal or inverted display orientation.



display contrast

Use this page to set or change the display day or night contrast.



display language

Use this page to set or change the display language.



keypad settings



keypad lock/unlock (optional)

When this option is enabled, the user can partially or completely lock the keypad.

When Full Lock is selected, all functions are locked.

In Partial Lock, you may only activate accessories. Settings may not be changed in this mode.



When the user wants to lock the keypad he is asked to select a 4-digit code. The same code will be needed to unlock the keypad.



Next time he wants to lock the keypad, he will be prompted again to select a 4-digit code (same functionality as a Safe in a hotel room).

The keypad can be unlocked with a universal unlock code (3732) or by a reset of the keypad.



keypad color (optional)

If this option is available (depending on the spa configuration), the keypad rim color can be changed.

8 pre-defined colors are available. If the In.Mtx is installed, the keypad rim color can also be associated to an In.Mtx zone.

miscellaneous



miscellaneous

This menu gives access to modify the Warm Weather option and info messages in the media center.



warm weather

When pumps are running, they produce heat that may increase your water temperature. "Warm Weather" option gives you the option to bypass the pack filtration over-temperature feature. When Warm Weather is "OFF" the filtration over-temperature is disabled and your spa filtering will continue even if the water temperature is high.



info messages

Press displayhide key to modify message display: If hide option is selected, smart winter mode message will only appear when a SWM purge is in action. Otherwise the message will always appear when the spa is in a SWM condition.

If hide option is selected, heating suspended and filtering suspended messages will not appear.



about your spa system

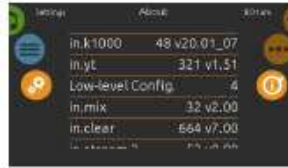

about

To get info about your spa system, slide the right wheel until the about icon is highlighted in the middle.

Information about the in.k1000 software number and the revision numbers of the different components of your system will be displayed.

wifi

(This function is available only if an In.touch module is connected to your system.)

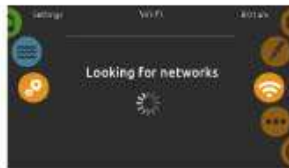

wifi settings

To modify wifi network settings, slide the right wheel until the wifi icon is highlighted in the middle.



wifi networks

After a few seconds the available networks will appear on-screen, as well as their signal strength. Select network will be identified by a green check mark. Swipe Up or Down the list to select your network.



wifi network password

If the wifi network is password protected, enter it when keyboard prompts. Use Enter key to validate the password.

If no password is required the In.touch will connect automatically.

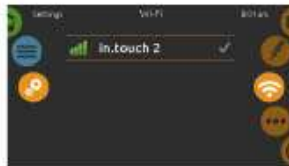

wifi (In.touch 2)

When an In.touch 2 is detected, this network will appear.



In.touch module not connected

If the In.touch module of your spa system is not connected, this message will be displayed.

electrical configuration



Please do not make changes in this section unless you are a qualified electrician.



audio mode

(only available if the system detects a connected In.stream 2 audio station)



To select the audio mode, slide the left wheel up or down until the audio icon menu is highlighted in the middle.

In the Audio page you can access the following:

- In.stream 2 on/off
- speaker calibration
- audio source selector
- disconnect bluetooth

To select an item, slide the right wheel until the desired icon is highlighted in the middle.

on/off



turn In.stream 2 ON (icon red)

Slide the right wheel until the power on/off icon is highlighted in the middle. Press the icon at the center of the screen to turn In.stream 2 on.

turn In.stream 2 OFF (icon green)

Press the icon at the center of the screen to turn In.stream 2 off.

main display

Press Play / Pause to start or pause playback of audio files.

Drag the volume slider to adjust the volume or tap the mute button to mute or unmute sound.

Press the last track or next track buttons to go to the previous song or skip to the next.

speakers setting



to modify your speaker settings

Slide the right wheel until the speaker calibration icon is highlighted in the middle.

You can adjust:

- balance
- fader
- subwoofer

Use the sliders to change the speaker settings at the desired level.

The fader and subwoofer sliders will only appear on the screen if the corresponding speakers are installed on the In.stream 2.

audio source selector



to select an audio source

Slide the right wheel until the source icon is highlighted in the middle.

In the menu list, the following sources are available:

- Bluetooth
- FM
- USB
- AUX 1

Simply select the desired one to use.

Note that only the sources installed on the In.stream 2 will be displayed in the source menu.

Please note that the Play/Pause and Change Track functions apply to devices using Bluetooth technology and USB, and will not work when AUX is selected as the source.

disconnect bluetooth



If a device with Bluetooth technology is connected to the In.stream 2, you can disconnect it by pressing the Disconnect key at the bottom of the screen.

Doing so will also prevent the In.stream 2 from automatically reconnecting to this specific device until it has been reconnected using the device itself.



sanitization mode

(only available if the system detects a connected In.clear water sanitization system)



To select the sanitization mode, slide the left wheel up or down until the In.clear icon menu is highlighted in the middle.

In the sanitization page you can access the following:

- In.clear on/off
- bromicharge
- boost level
- maintenance level

To select an item, slide the right wheel until the desired icon is highlighted in the middle.

on/off



turn In.clear ON - Step 1 (icon red)
Slide the right wheel until the power on/off icon is highlighted in the middle. Press the icon to turn In.clear on.



turn In.clear OFF - Step 2 (icon yellow)
Press icon for 5 seconds to confirm power off.

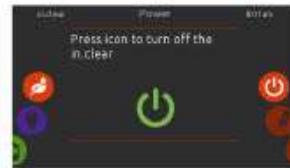

turn In.clear OFF - Step 3 (icon green)
Press the icon to turn off the In.clear.

bromicharge™ level

When performing a test, the BromiCharge™ gauge indicates the approximate sodium bromide level of the spa water.



The green zone in the center area of the gauge should be targeted for optimal performance.

To perform a water test, slide the right wheel until the add BromiCharge™ icon is highlighted in the middle.

There is no need to add sodium bromide if the indicator is in the green zone.

When adding sodium bromide, the gauge indicator will gradually shift to the right. When adding clean water to the spa, the indicator will shift to the left.

In order to achieve the proper level, start pumps and add 227g (5 lb) of BromiCharge™ at a time and always allow 5 minutes for the gauge to react before adding more sodium bromide.



boost level



modify the boost level

Boost mode is activated automatically 5 minutes after starting a pump. Boost mode increases the bromine generation rate to keep the water clear, clean and soft. As a rule of thumb, its level correspond to the number of bathers.

To modify the boost level, slide the right wheel until the boost icon is highlighted in the middle and use the up or down arrow keys to adjust the level.

Click on the the level icon to confirm your selection.

maintenance level

Use a test kit to check the bromine level. It should be between 3-5 ppm. If the bromine level stays within that range for 3 consecutive days, your maintenance level is well adjusted.



modify the maintenance level

To verify or modify the maintenance level, slide the right wheel until the maintenance icon is highlighted in the middle.

The recommended maintenance level is 12.

Use the up or down arrow keys to adjust the level.

Note that the level can be adjusted by Increment of 2 using the up and down arrow keys.



Please note that it is not recommended to change the maintenance level at steps greater than 2. A confirmation will be asked by the system if you do.

If you do, retest the bromine level the day after. If the bromine is not in the 3-5 range and is higher than 5 ppm, decrease the maintenance level. If the bromine is lower than 3 ppm, increase it. Repeat until the test reads a bromine level in the 3-5 range.



color mode

(only available if In.mix is detected among the spa accessories)



To select the color mode, slide the left wheel up or down until the In.mix icon menu is highlighted in the middle.

In the color page you can access the following:

- zone selection
- changing colors
- on/off
- synchronizing zones
- intensity

in.mix functions



zone selection

To select a zone, turn the right wheel until the desired icon is highlighted in the middle. This selection allows you to modify its color.

changing colors

Once a zone has been selected, use the color wheel to choose the desired color or the rainbow icon to get changing colors.

on/off

There are two ways to turn In.mix on or off. The first one is by using the Light icon on the SPA Screen. The second way is by touching the light bulb icons located each side of the intensity bar.

synchronizing zones

The synchronization/desynchronization icon allows you to match the color of the selected zone with the other zones.

intensity

Located at the bottom of the screen, the slider allows you to modify the intensity of the color.



too much water on display



wipe screen

This message appears when too much water is detected on the touch screen. Simply wipe away excess water.

installation error messages

Upon connecting the i1000 to your spa system you may see one of two error messages. Please follow the instructions in the message or contact your dealer for more information.

 **WARNING**

There's a problem communicating with the pack. Please check keypad connections or update pack software.

 **Upload**

The spa pack does not have valid software. Please insert valid i1000 stick to reprogram spa pack.

Error messages on-screen list and definitions.

<http://geckokeypads.com/i1000errormessages/>



in.touch 2

Easily integrate your spa to the Internet of Things!



Gecko Alliance's in.touch 2 ultimate mobile remote control for your spa

Simplest of setups

in.touch 2 eliminates all the complexities of connecting your spa to the Internet and transforms your iOS or Android smartphone or tablet into your ultimate mobile remote control. in.touch 2 comes with state-of-the-art apps and 2 pre-paired radio frequency transmitters, one being part of your spa system and the second one being connected to your Internet router. Both RF transmitters are pre-linked to one another, enabling an immediate and perfect communication between you and your spa.

Strong and long range communication signal

Through their proprietary RF technology, in.touch 2 transceivers emit a strong, stable and long range signal

between your spa and your router (about 3 times longer than regular Wi-Fi signal). No need for repeaters or boosters: your spa will always remain within reach in typical backyard settings.

State-of-the-art apps with push notifications

in.touch 2 streamlined iOS and Android applications make it very easy to control and program all the functions and features of your spa from your smartphone or your tablet. Even when you're away from home, you get a full control of your water care settings, filtration cycles, water temperature, accessories and a lot more. Push notifications will always keep you informed on the status of your spa, even when your app is not open.



simplest of setups

in.touch 2 eliminates all the complexities of connecting your spa to the Internet

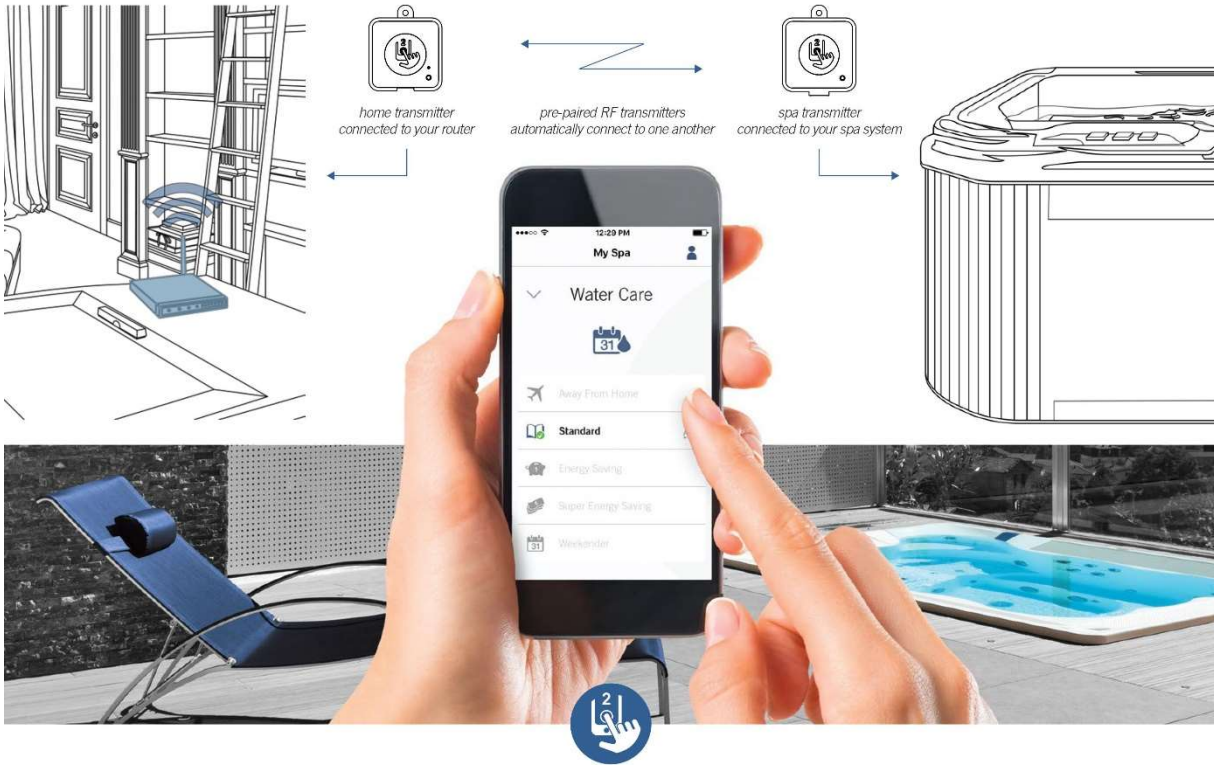

in.touch 2 ultimate mobile remote control for your spa

strong and long range signal

in.touch 2 features proprietary RF technology

- long range up to 300 foot line of sight with normal housewall obstruction (about 3 times normal Wi-Fi signal)
- frequency of operation 915MHz for North America and 868MHz for Europe (2 different models)
- compatible with X and Y series versions 2012 and earlier
- compatible internet RJ45
- NA Part ID: 0608-521023 0608-521020 (Gecko Depot)
- CE Part ID: 0608-521024 0608-521021 (Gecko Depot)
- operating temperature: -4°F (-20°C) to 140°F (60°C)
- storage temperature: -22°F (-30°C) to 185°F (85°C)
- UL & CSA certifications: UL 1563 Sixth Ed. UL file: E182156 CAN/CSA C22.2 No. 218.1-13 FCC part 15, subpart B ICES-003
- CEM Europe: IEC 60335-1 IEC 60335-2-60 EN 55014-1, EN 55014-2 EN 61000-3-2, EN 61000-3-3

state-of-the-art in.touch 2 apps

with push notifications

- for iOS and Android smartphones and tablets
- instant spa status
- control of water temperature
- control of spa water care settings (economy & filtration)
 - away from home
 - beginner
 - energy saving
 - super energy
 - weekender
- push notifications
- system errors
- reminders
- accessories
 - pumps
 - lights
 - waterfalls
 - blower
- message center
 - error message log
- available through:
 - apple app store
 - android google play



home transmitter

connected to your router with an Ethernet cable



spa transmitter

connected to your spa pack





in.stream 2

Streamed from your spa,
your favorite music never sounded so good!



Introducing Gecko Alliance's in.stream 2
outdoor audio station for spas and the whole backyard!

Awesome sound quality

Designed to deliver a clean, crisp rich sound in the high-fidelity rendition expected by music lovers, in.stream 2 features Class D amplifier technology to enhance your outdoor audio experience.

All in one audio system and power supply

Compact, rugged and splash proof, in.stream 2 has a built-in power supply specifically designed to get the most of its amplifier. Delivering 300W peak at low distortion, it features a built-in sub amplified output with integrated digital filter and adjustable volume.

Full control of your audio from spa side

Easy to install, in.stream 2 can be controlled from the edge of the spa through in.k1000, in.k800 or in.k500 main keypads of Gecko's X and Y series spa systems. Its interface features full control of audio sources, volume and settings, and display of song tag information.

It features Bluetooth audio for wireless streaming of your music from your favorite providers, apps, internet radio or podcasts, USB memory stick connector, auxiliary audio input and built-in FM. Comes with optional docking stations for protection of your portable player.



in.stream 2

splash-proof IPx5 rated outdoor audio station for spas and the whole backyard



- built-in universal power supply
- robust, fully splash proof (IPx5) enclosure
- powerful and efficient Class D amplifiers
- up to 4 speaker outputs (200W at 4 Ohms)
- 1 subwoofer output (100W at 2 Ohms)
- 1 auxiliary input
- 4x audio sources: Aux in, USB stick, FM radio and Bluetooth streaming
- smartphone charger through USB connector
- 140 °F (60 °C) max. operating temperature
- wall mount installation
- firmware field upgradable
- dimensions: 9.8" width x 8.9" height x 2.6" thickness

total audio control

from the edge of your spa!

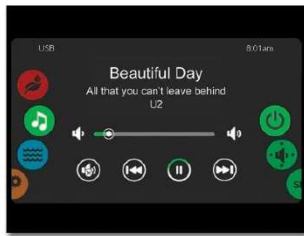

in.k1000 main keypad



in.k800 main keypad



in.k500 main keypad

in.stream 2 Pro +

with Bluetooth, USB direct connection, auxiliary audio input, built-in FM, 4 speaker outputs and 1 subwoofer output



in.stream 2 Mid

with Bluetooth, USB direct connection, auxiliary audio input, 2 speaker outputs and 1 subwoofer output



in.stream 2 Basic

with Bluetooth, 2 speaker outputs and an auxiliary audio input



in.stream 2 dimensions



Wireless set-up - Pairing with a Bluetooth technology enabled device

*The in.Stream system is ready to pair when it is not already connected to another device.

**To pair your device with the in.stream, first make sure you are close enough to the system and that it is turned on.

- Open the Bluetooth settings on your device. The location of the settings will depend on the device you are using.
- In these settings, turn Bluetooth on, if it is not already.
- Choose "Gecko in.Stream" from the list of available devices.
- When prompted, enter 5555 as the password.

Your device should now be paired with the in.stream system, and ready to use.

*If your phone and the in.Stream do not pair, it might be necessary to turn off your Bluetooth and repeat the steps above.

Notes

- The in.Stream will keep up to 8 devices in its memory.
- If one of these devices is in range and has its Bluetooth turned on it will automatically pair with in.Stream.
- If the number of devices used with your in.Stream exceeds 8 the first device in its memory will automatically be erased. The device can easily be added again by following the steps for pairing.
- It is possible to erase all pairing information from the memory by holding down the AUX button for 7 seconds or the single switch for 10 seconds and then releasing.
- If more than one device tries to connect to the in.Stream system, the priority goes to the first device that is available during searching.

*** Aspen Spas recommends consulting a contractor or structural engineer before installing a spa on an elevated deck.**

**** Aspen Spas must be wired in accordance with all applicable local electrical codes.**

*****All electrical work should be done by an experienced, licensed electrician, utilizing correct wire, conduit, and fittings.**

ASPEN SPAS SPECIFICATION

Spa Model	Seating Capacity	Dimensions L x W x H	Water Capacity	Dry Weight	Filled Weight	Electrical Requirements *Single Phase*
S.W.I.M. Aqua Motion Aqua Family		190.5" x 94.5" x 54"H	2000 Gallons	2000 lb	18680 lb	ES: 230V - 60Hz 60A GS: 230V - 60Hz 47A AM: 230V - 50Hz 40/50A AF: 230V - 50Hz 32/40A
Arcadia Dynamics Aria II Standard Aria II	7 Adults	91" x 91" x 38"H	525 Gallons	950 lb	5500 lb	ES: 230V - 60Hz 54A GS: 230V - 60Hz 41A VS: 230V - 60Hz 29A DA: 230V - 50Hz 32/40A SA: 230V - 50Hz 20/32A
Pinnacle Dynamics Oceana Standard Oceana	6 Adults	91" x 91" x 38"H	525 Gallons	950 lb	5500 lb	ES: 230V - 60Hz 54A GS: 230V - 60Hz 41A VS: 230V - 60Hz 29A DO: 230V - 50Hz 32/40A SO: 230V - 50Hz 20/32A
Alpine Standard Venetia	7 Adults	82" x 92" x 36.5"H	475 Gallons	900 lb	5250 lb	ES: 230V - 60Hz 42A GS: 230V - 60Hz 33A VS: 230V - 60Hz 29A SV: 230V - 50Hz 20/32A
Monarch Dynamic Illusion Standard Illusion	5 Adults	82" x 82" x 37"H	425 Gallons	800 lb	4500 lb	ES: 230V - 60Hz 42A GS: 230V - 60Hz 33 A VS: 230V - 60Hz 25A DI: 230V - 50Hz 20/32A SI: 230V - 50Hz 16/20A
Eldorado Dynamic Obsession Standard Obsession	5 Adults	82" x 82" x 37"H	425 Gallons	800 lb	4500 lb	ES: 230V - 60Hz 42A GS: 230V - 60Hz 33A VS: 230V - 60Hz 25A DO: 230V - 50Hz 20/32A SO: 230V - 50Hz 16/20A
Quattro Dynamic Glee Standard Glee	4 Adults	66" x 84" x 34"H	300 Gallons	600 lb	3200 lb	ES: 230V - 60Hz 33A GS: 230V - 60Hz 29 A VS: 230V - 60Hz 25A DG: 230V - 50Hz 20/32A SG: 230V - 50Hz 16/20A
Colorado	4 Adults	66" x 84" x 34"H	300 Gallons	600 lb	3200 lb	ES: 230V - 60Hz 32A GS: 230V - 60Hz 26A VS: 230V - 60Hz 24A
Pioneer Tao	5 Adults	68" x 78" x 34"H	300 Gallons	600 lb	3200 lb	ES: 230V - 60Hz 32A GS: 230V - 60Hz 26A VS: 230V - 60Hz 24A TAO: 230V - 50Hz 13/20A
Northstar Standard Joy	5 Adults	82" Round x 34"H	300 Gallons	600 lb	3200 lb	ES: 230V - 60Hz 32A GS: 230V - 60Hz 26A VS: 230V - 60Hz 24A SJ: 230V - 50Hz 16/20A



4609 McRee Avenue
Saint Louis, MO 63110
Ph: 314-776-5050
Fax: 314-776-7070
aspenspas.com
sales@aspenspas.com
service@aspenspas.com